

ENSEMBLE
D E S I G N S

Catalyst CV

User Manual

Date of Publication:12/10/98
Software Version:0.9.5.41 or later

ENSEMBLE

D E S I G N S

Serial Box Convertors

For high quality conversion between all analog formats and serial digital component, Serial Box offers the ideal way to drive picture monitors, waveform monitors, switchers, VTRs and DDRs. All Serial Box Convertors feature full 10 bit processing in YUV color space conversion for the most accurate output signal possible.

Catalyst CV™ Networkable Switcher & Keyer

Catalyst has all the switching and keying power needed in a traditional environment, including Linear, Luminance, Chroma and Additive keying. Ethernet connectivity for workstation interface and one-setup graphics keying makes it perfect in graphic suites, telecine and post, stand-alone or downstream, for 10 bit serial component applications.

Networkable Video Gateway for Mac/PC/SGI

Use the Multibuffer™ DS-1 Video Gateway for flawless graphics transfers between the computer and the video world. As an ethernet networkable device it is available as a resource to all workstations in your facility. Video and Alpha (key) are automatically sent to independent, simultaneous outputs, providing full support of graphics keying in editing and on-air environments.

TBC Control Systems

TBC Controllers offer simplicity that revolutionizes your tape system by controlling video, chroma, setup, hue and timing of digital and analog VTRs, TBCs, and Frame Syncs. Built-in networkability means any size system can be achieved with control of any VTR from any control panel.

Carbon™O2 Video I/O Stuff

Carbon™ provides analog video and key inputs and outputs for the Silicon Graphics O2 workstation. Carbon is great for using O2 in an analog environment with a beta deck or other analog gear. Its built in key channel enables the O2 to integrate into broadcast and post environments.

For more information on Ensemble products, contact us at:

Ensemble Designs PO Box 993 Grass Valley CA 95945 USA
tel: (530) 478-1830 fax: (530) 478-1832
email: info@endes.com www.ensembledesigns.com

PREFACE

This manual provides complete application, installation, setup and user information for the Catalyst CV Switcher and Keyer.

The manual is divided into the following sections:

Catalyst CV Overview

This section describes the main uses of Catalyst CV and gives examples of common applications.

Installation

Installation of Catalyst to your external devices and setting the frame front panel controls for system parameters are covered in this section.

Catalyst CV Control Panel Operation

This section gives a full description of how to use the control panel and the menus for controlling Catalyst CV.

Control With SGI or PC/NT Applications

Using an SGI, PC or NT workstation to control Catalyst is described in this section.

Troubleshooting

This section gives Catalyst CV troubleshooting tips.

Product Specifications

Product specifications are given in this section.

Table of Contents

CATALYST CV OVERVIEW	1
Applications	3
Standalone Switcher/Keyer	3
Telecine Frame Reference	4
Networking with Computer Workstations	5
INSTALLATION	7
Inputs	7
Outputs	7
Buffers	8
Reference Inputs	8
Analog Reference A or B	8
Digital Input #1	11
Freerun	11
Editor Port	11
Diagnostic Port	12
Control Panel	12
10BaseT 15-pin AUI Connection	13
Thinnet BNC Connection	13
GPI/Remote	13
Frame Front Panel Operation	15
LCD Contrast Adjustment	15
Buffer Control	16
Make Test Patterns	16
Freeze Control	18
Buffer Timing	18
Set Default	18
Router Control	19
Genlock & Timing	19
Remote Port Mode	22
Edit Port Mode	22
Network Status	22
CATALYST CV CONTROL PANEL OPERATION	25
Getting Started	25
LCD Display, Pushbuttons and Control Knobs	25
LCD Display Adjustment	25
Numerical Keypad and Function Keys	26
Set Transition Rate	26
Memory Registers	28

Lever Arm	28
Menu Selections	28
Home Menu (4:2:2)	28
Background	31
Key Fill	34
Wipe	35
Ext Mask	36
Mask	40
Shadow	41
Buffer Control	42
Key Type	44
Engineering Setup	47
CONTROL WITH SGI OR PC/NT WORKSTATIONS	51
Getting Started	52
r Commands	52
rlogin Usage	52
rsh Usage	53
Commands	53
config	53
?	54
help	55
exit	55
logout	55
freeze	55
freeze 'space' function	56
hostaddress	57
hostname	57
hphase	57
vphase	58
info	58
mtp	59
route	59
genlock	62
dm	62
Function Control Commands	63
Routing Control	64
Key Control	64
Other Controls	65
rcp Commands	66
Transferring RGB Pictures	66
Shell Scripts	66

CATALYST CV OVERVIEW

The Catalyst CV Switcher/Keyer is a 10 bit ITU-R 601 component digital multi-purpose video tool that can be used as a traditional keyer or small switcher. It operates as a single layer keyer with four buses: Background A, Background B, Key and Fill. Each bus has its own matte generator.

It has up to 4 live digital inputs, 4 digital outputs, and 4 internal frame buffers. Any of the inputs, buffers and matte generators can be used for background, key and fill signals on any bus. Full routing between inputs and internal frame buffers provides flexibility in internal and external source selection. Internal processing is 16 bit.

Keying capability includes luminance, linear, additive and chroma keying with fully positionable transparent dropshadow and adjustable masking.

Independent control of key layer and background transitions with cut, mix and wipe effects are built into Catalyst CV for layering and effects.

Images from a computer or computer graphic images can be sent over ethernet to Catalyst's internal framebuffers and used as background, key or fill material. This allows keying of computer graphics and titles directly over live video without digitizing the background video into your workstation.

Catalyst CV is based on the MultiBuffer DS-1 from Ensemble Designs. The Catalyst CV Combiner module plugs into the video board inside the MultiBuffer chassis. All the functionality of the MultiBuffer DS-1 is included with every Catalyst CV, including flawless graphics transfers between Mac, SGI and PC workstations and serial digital video.

Catalyst CV Overview

Catalyst can be controlled by an optional tabletop control panel that offers 100 internal memory registers to save clip, gain and key type settings. The serial interface uses GVG 200 protocol and enables complete control of all Catalyst functions. Keyer functions such as wipe, mix and cut can also be triggered by GPIs. Computer control includes interfaces for use on Macintosh, Silicon Graphics and PC workstations with full control using Unix commands.



Catalyst CV Networkable Component Digital Switcher/Keyer

Applications

Complete keying capability paired with an ethernet interface makes Catalyst CV a unique and powerful solution for both traditional editing and computer graphics environments.

Standalone Switcher/Keyer

Catalyst CV is a perfect stand alone keyer or small switcher. It can also be used downstream from an analog or digital production switcher. For mastering to D1, Digital Betacam or a Digital Disk Recorder, Catalyst CV can be used as shown in the illustration below.

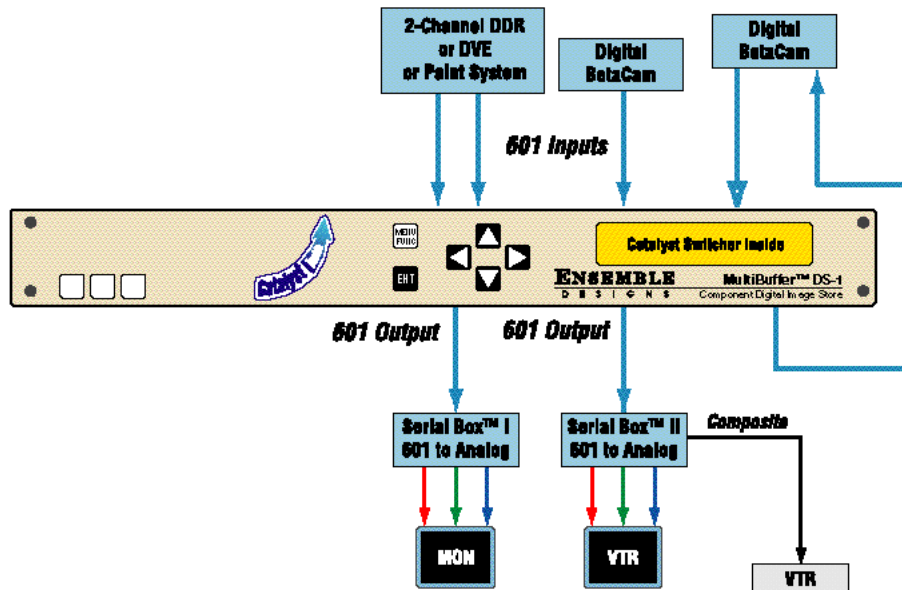

Standalone Switcher/Keyer Application

Catalyst CV Overview

Telecine Frame Reference

Catalyst CV is a perfect solution for wiping between your telecine and a still store for frame reference comparison. Additionally, if SmartStore™ FrameBuffers are installed, reference stills can be loaded into the buffers enabling you to wipe between the telecine input and the frame buffers for precise comparison. Wipe softness and positioning can be utilized for dirt fixes. Built-in safe title and other internally generated test patterns are easily loaded into the framebuffers. Slates can also be created on your computer then sent over ethernet to the framebuffers.

Telecine material can be compared with frames stored inside Catalyst or with an external still store or DDR as illustrated below.

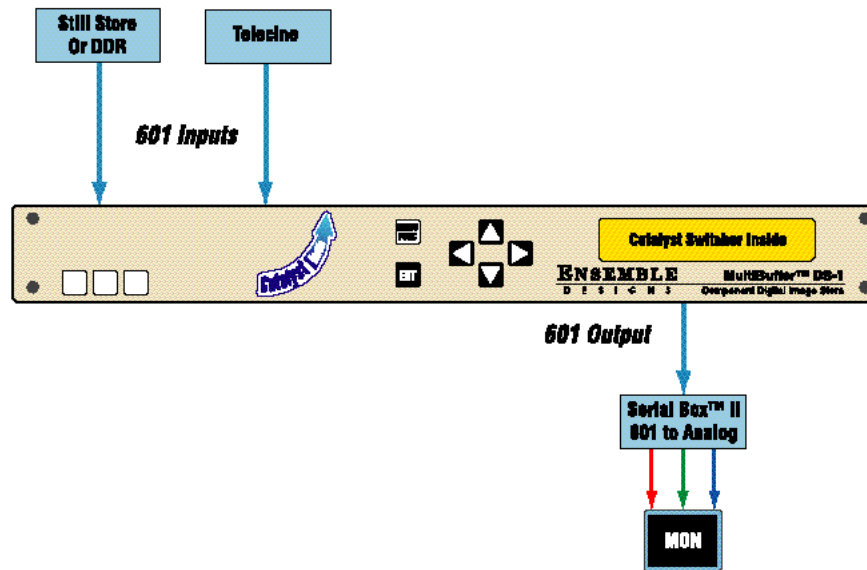

Telecine Reference Application

Networking with Computer Workstations

Catalyst CV lets computer graphics be keyed directly over live video without digitizing the background video into your workstation. Macintosh, PC and SGI graphics can be sent over ethernet to the internal framebuffers and used as background, key or fill material or as a full-screen graphic.

An application using Catalyst CV's computer interface is illustrated below.

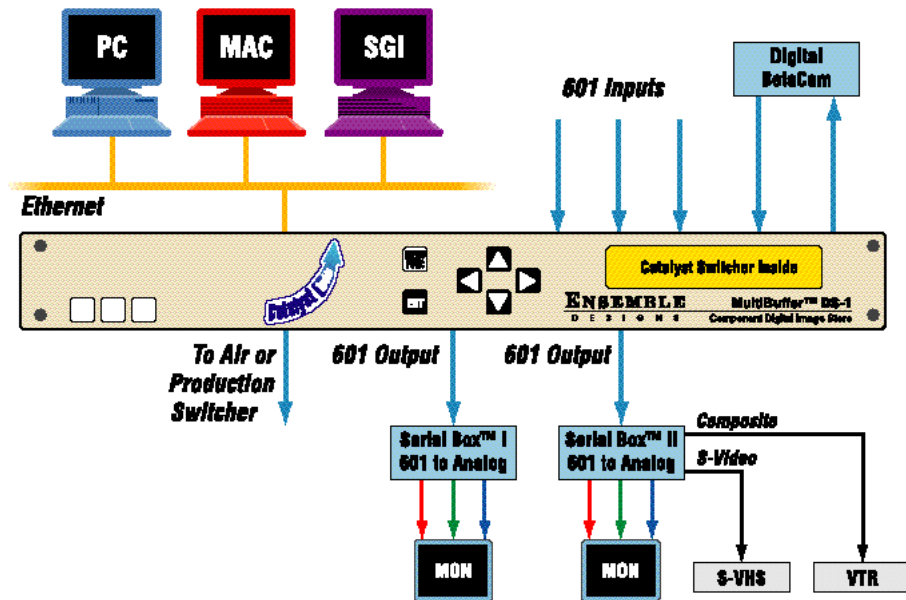

Computer Networking Application

Catalyst CV Overview

INSTALLATION

The Catalyst CV frame electronics is 1 rack unit, 19" wide, 1.75" high and 17" deep and weighs 12 pounds. Rack ears are included and screw onto the sides of the frame chassis for rack mounting. Rear rack supports are also included. Power specifications are 100-230 VAC, 50/60 Hz, 60 VA. CE Compliant where required. Install the electronics frame in a standard equipment rack if desired.

The external connections to the Catalyst backplane are explained in the following sections. The Catalyst CV backplane is illustrated on the next page.

Inputs

Catalyst CV can have up to 4 Serial Digital 259M inputs with reclocked active loopback outputs. All inputs have an 8 line autotime window. The system comes standard with 2 inputs.

Connect the desired sources to the active Serial Component Input BNCs on the back of the frame electronics. (Inputs 1 and 2 are standard, inputs 3 and 4 are optional). Catalyst accepts serial digital SMPTE 259M video. Use 75 ohm coaxial cable for connecting the inputs.

Outputs

Catalyst CV can have up to 4 independent Serial Digital 259M output channels, each with an additional buffered output.

Connect the active Serial Component Output BNCs to the desired output destination. (Outputs 1 and 2 are standard, outputs 3 and 4 are optional). Outputs can be fed to any device that accepts serial digital video SMPTE 259M video. Use 75 ohm coaxial cable to connect the outputs.

Catalyst CV Installation

Buffers

Catalyst CV can have up to 4 internal SmartStore™ FrameBuffers installed. Buffers are optional and are not required for Catalyst operation.

Each buffer holds 1 frame of video and can be frozen or unfrozen. The video in a buffer can come from 3 sources, a Catalyst digital video input, an input from an external workstation, or an internal test pattern. Also, Catalyst's internal routing system allows routing of one buffer to another, which can be helpful for special timing needs. Each buffer can be independently timed and can provide up to 1 frame of delay as needed. (For most applications, buffers do not need to be timed.)

Reference Inputs

There are four sync reference source choices available as listed below:

- Analog A
- Analog B
- Digital Input #1
- Freerun

One of these sources must be chosen as the sync reference in the Genlock & Timing selection through the front panel controls explained in the next section.

Analog Reference A or B

Two BNCs are available on the back of the frame for use with analog reference signals. The analog reference signal must contain composite H and V sync, at any level from 300 mV to 4 V peak-to-peak. Standard color black from a Sync Pulse generator is a good choice for a reference source.

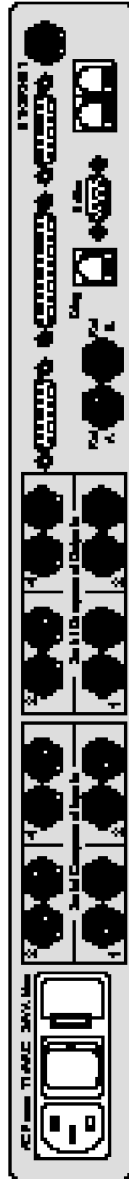

Catalyst CV Back Panel

Catalyst CV Installation

The two BNCs can be set for a standard loop-through mode or for each BNC to be an independent reference input. Internal jumpers on the main video board must be set to configure these two connectors as either high-impedance loop-through or independent, internally terminated inputs. The jumpers are set at the factory for loop-through mode.

If you desire to use the independent mode, remove the top cover of the frame electronics and locate the jumpers, J9 and J10, located at the rear of the main circuit board behind the Ref A and B BNCs. Move the jumpers to the right most two pins as illustrated in the figure below.

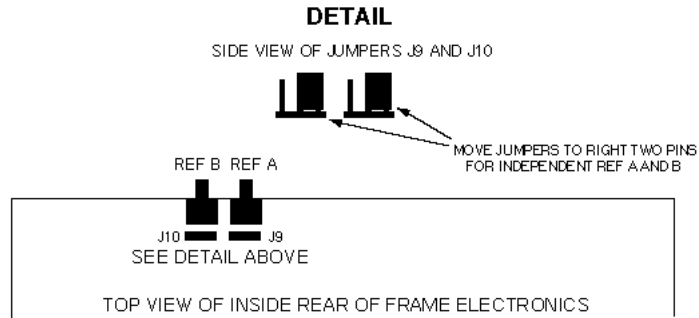

Setting Analog Reference Jumpers to Independent

To use the loop-through mode, connect the analog reference signal to one of the BNCs and loop through to the next device. You will need to set the Genlock Source to Analog Ref A or B when setting the front panel controls in the next section.

If you have set the jumpers for two independent inputs, you can feed two different reference signals to the Analog Ref A and B (such as 525 and 625) and in the next section, set the Genlock Source for either A or B depending on which reference signal you want to use.

Digital Input #1

When genlocked to Digital Input #1, the 27 MHz clock and Horizontal and Vertical timing are derived from the input signal feeding Digital Input #1. For this setting, choose Digital Input 1 under the Genlock Timing menu. (Note that an external digital signal input must be connected to Input #1 for this setting.)

Freerun

When freerun is selected, an internal sync generator, driven by the internal 27 MHz crystal oscillator, provides the reference signal. No cabling is required. Select Freerun under the Genlock Timing menu for this setting.

Editor Port

The editor port uses a standard 9-pin D connector. Catalyst CV emulates the Grass Valley 200 protocol. The Editor port mode must be selected under Edit Port Mode in the setup menus using the front panel controls.

Diagnostic Port

The diagnostic port is not used at this time.

Control Panel

If you are using the Catalyst CV control panel, connect the control panel to the frame LAN (local area network) port with the standard phone cable provided or a custom-made simple twisted pair LAN cable. Connect one end of the cable to the phone connector on the control panel and the other to one of the two phone connectors on the frame. Terminate the unused phone connectors on the panel and frame with 100 ohm resistors. (LAN terminations are installed at the factory for your convenience.)

Computer Network Connections

The Catalyst CV frame supports both 10BaseT and Thinnet (10Base2) ethernet systems. To connect to the ethernet port, refer to the instructions below.

10 BaseT 15-pin AUI Connection

To use 10BaseT, an external transceiver must be installed to the 15-pin AUI connector (to the upper left of the LAN phone connections.). Conventional 10BaseT cabling is then run from that transceiver to the hub serving the system. 10BaseT installations require a central hub to which each network device connects. A properly installed 10BaseT connection will illuminate the "link" indicator on the transceivers at the frame and at the hub.

Thinnet BNC Connection

Thinnet cabling runs daisy-chain fashion to all devices on the network. The frame can be equipped with an optional single female BNC for connection to the network via a Female/Male/Female T-connector. 50 ohm coax (RG58) is run between each device, with a 50 ohm termination on the unused half of the T-connector at each end of the chain.

Ethernet setup and status checking is done through the front panel controls. Refer to the next section, Frame Front Panel Operation for more details.

GPI/Remote

GPIs can trigger cuts and dissolves and restore a Memory Register. The GPI interface connector is a 15-pin male connector with the pinouts as shown in the figure below.

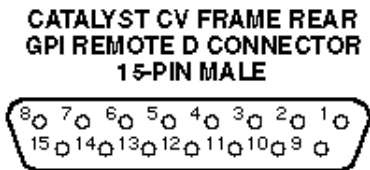

1	GPI IN 1	Toggles Buffer 1 Freeze
2	GPI IN 2	Toggles Buffer 2 Freeze
3	GPI IN 3	Toggles Buffer 3 Freeze
4	GPI IN 4	Toggles Buffer 4 Freeze
5*	GPI IN 5	Key Only Cut
6*	GPI IN 6	Key Only Mix
7*	GPI IN 7	Bkgd Only, Cut
8*	GPI IN 8	Bkgd Only, mix
9	GPI OUT 1	High when Buffer 1 is frozen
10	GPI OUT 2	High when Buffer 2 is frozen
11	GPI OUT 3	High when Buffer 3 is frozen
12	GPI OUT 4	High when Buffer 4 is frozen
13	GPI OUT 5	Programmable
14	GPI OUT 6	Programmable
15	GROUND	

* Applies to Catalyst CV with 0.94b27 or later PR OMs

GPI Connector Pinouts

Catalyst CV Installation

The following engineering points should be considered when connecting the GPI inputs and outputs:

1. GPI inputs are active low, sampled at the vertical interval.
2. GPI outputs require 470 ohms to LED when using a lamp driver.
3. When GPI Output is used as a logic output, do not use a pullup resistor. Use a 1N4148 diode in series with the load for isolation, with cathode towards the frame for active low.
4. GPI operation requires Catalyst CV with 0.9.4b27 or later PROMs.

Frame Front Panel Operation

Frame system parameters must be set for proper operation using the Catalyst CV frame electronics front panel controls. The top level menu choices for the parameters to be set are as follows:

- Buffer Control
- Router Control
- Genlock and Timing
- Remote Port Mode
- Edit Port Mode
- Network Status

A full menu tree describing each menu setting is provided in Appendix A of this manual.

The controls for setting the menu functions are located at the front of the Catalyst CV frame (also marked MultiBuffer DS-1) as shown below. Each menu function is explained in detail in this section.

To access the menus, press the Menu Func button so it is lit and observe the LCD display to the right. Use the RIGHT, LEFT, UP and DOWN arrow keys to scroll through and select the menu choices where instructed and use the ENT button to make your selection.

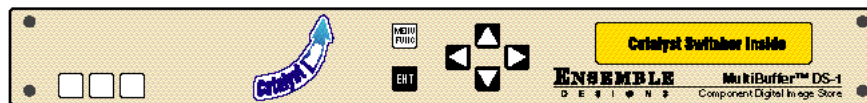

Catalyst CV Frame Electronics Front Panel

LCD Contrast Adjustment

To adjust the contrast of the LCD display, press and hold down the menu button and use the UP and

Catalyst CV Installation

DOWN arrow keys to adjust the light and dark contrast as desired.

Buffer Control

Each optional framebuffer can be set for the following parameters:

- Make Test Patterns
- Freeze Control
- Buffer Timing
- Set Default

Scroll to Buffer Control and then enter the desired function by pressing the DOWN arrow when it appears on the screen.

Make Test Patterns

If you would like a Test Pattern written into a buffer, select the Make Test Patterns selection and choose the Pattern Function from the following:

- Make 442 Patterns
- Make 444 Patterns
- Set Pattern IDs

Make 422 Patterns - Scroll to the Buffer (1-4) into which you would like to store the pattern and then scroll to the pattern you would like and press ENTER. There are 16 patterns available, refer to the foldout menu tree in Appendix A for a complete listing.

Make 444 Patterns - Two buffers are required to store a 444 pattern. Buffer pairs are selected in the menu. Scroll to the Buffer combination (Buffers 1 & 2, 2 & 3, 3 & 4, and 1 & 4) into which you would like to store the pattern and then scroll to the pattern you

would like and press ENTER . There are 3 patterns available in this selection:

- YCrCb Bars
- RGB Bars
- Pulse and Bars

Set Pattern IDs - Each pattern can be embedded with a 4-digit text or number ID for identification. The ID can be positioned horizontally and vertically as desired. Set the pattern ID as follows:

Scroll to Set Pattern IDs with the DOWN arrow. To Set ID Text , use the RIGHT and LEFT arrows to scroll to each digit, then use the UP and DOWN arrows to select the desired character. Press ENTER to make your selection.

Then, to enable the ID, scroll to Turn ID On or Off and select ON or OFF .

You may then set the horizontal and vertical positioning of the ID. Scroll to Set ID Vert Pos and choose from the following vertical positions:

- Top
- Top-Center
- Center
- Bottom Center
- Bottom

Scroll to Set ID Horiz Pos and choose from the following horizontal positions if desired:

- Left
- Center
- Right

Catalyst CV Installation

Freeze Control

The next function under the top level Buffer Control is Freeze Control. You may let video run through a buffer or freeze it at a desired point. Scroll to the desired buffer 1-4 then set the freeze control to ON if desired.

Buffer Timing

Generally, buffer timing does not need to be adjusted. H and V are generally both left at 0 which causes the buffer output to be in time with the reference.

In special cases, you may want to adjust buffer timing. This can be handy when routing an input through one or more buffers in order to achieve one or more frames of delay. A maximum of one frame of delay can be achieved per buffer.

Setting vertical timing to a negative number causes the buffer output to be early with respect to the reference. A positive number would result in the buffer output being later with respect to the reference. Vertical timing is adjusted in lines; horizontal timing is adjusted in clocks.

Scroll to Buffer (1-4) V Timing to make vertical timing adjustments.

Scroll to Buffer (1-4) H Timing to make horizontal adjustments.

Set Default

After setting a buffer to Freeze or Unfreeze, selecting a test pattern (if Freeze was chosen) and adjusting timing as needed, scroll to the desired buffer and press ENTER to save these settings into non-volatile memory.

Router Control

Catalyst CV has a 12 x 14 internal routing switcher that feeds four keyer buses. The routing is very flexible, any signal can be used for any keying effect. Refer to the functional block diagrams on the following pages for a pictorial view of how the router processes signals throughout the system and to help you choose the routing setups.

Each source is assigned to a destination using this menu function. The menu tree in Appendix A shows a complete list of the source and destination choices.

Enter the Router Control menu, then use the UP and DOWN arrow keys to scroll to the source. Use the RIGHT and LEFT arrow to scroll to the desired destination for this source. Hit ENTER to make your selection. "Take" will briefly be displayed to confirm the routing change has occurred.

Genlock & Timing

This menu selection consists of the Genlock Timing and the Line Standard selections. As explained earlier in the Cabling section, the system must be genlocked to either an external analog house sync reference or Digital Input # 1 or it may freerun.

Scroll to the Genlock Source selection and choose the sync reference you will be using. Choose from Analog Ref A, Analog Ref B, Digital Input #1 or Freerun. If you are not sure which reference to use, refer back to the Reference Inputs heading earlier in this section for an explanation.

Scroll to the Line Standard and select either 525 or 625 lines depending upon your line rate requirement.

Catalyst CV Installation

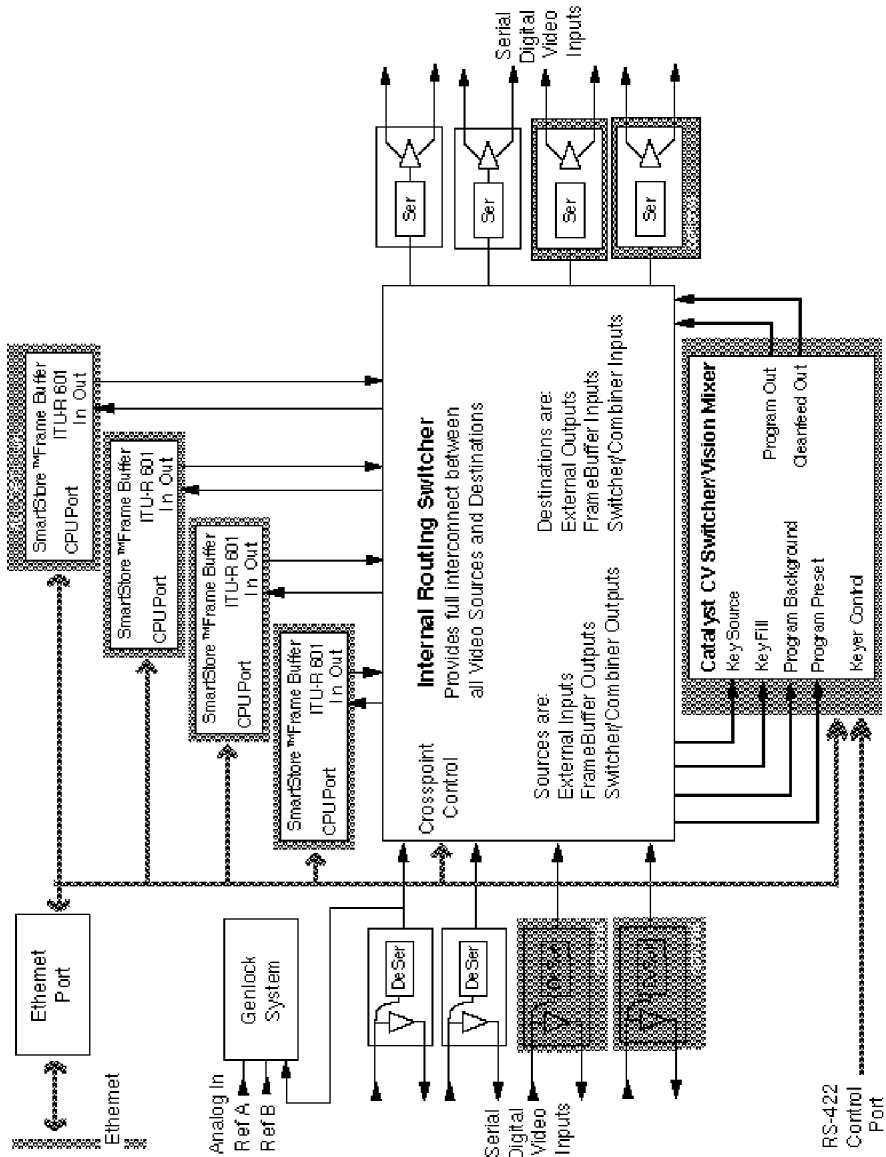

Catalyst CV Functional Block Diagram

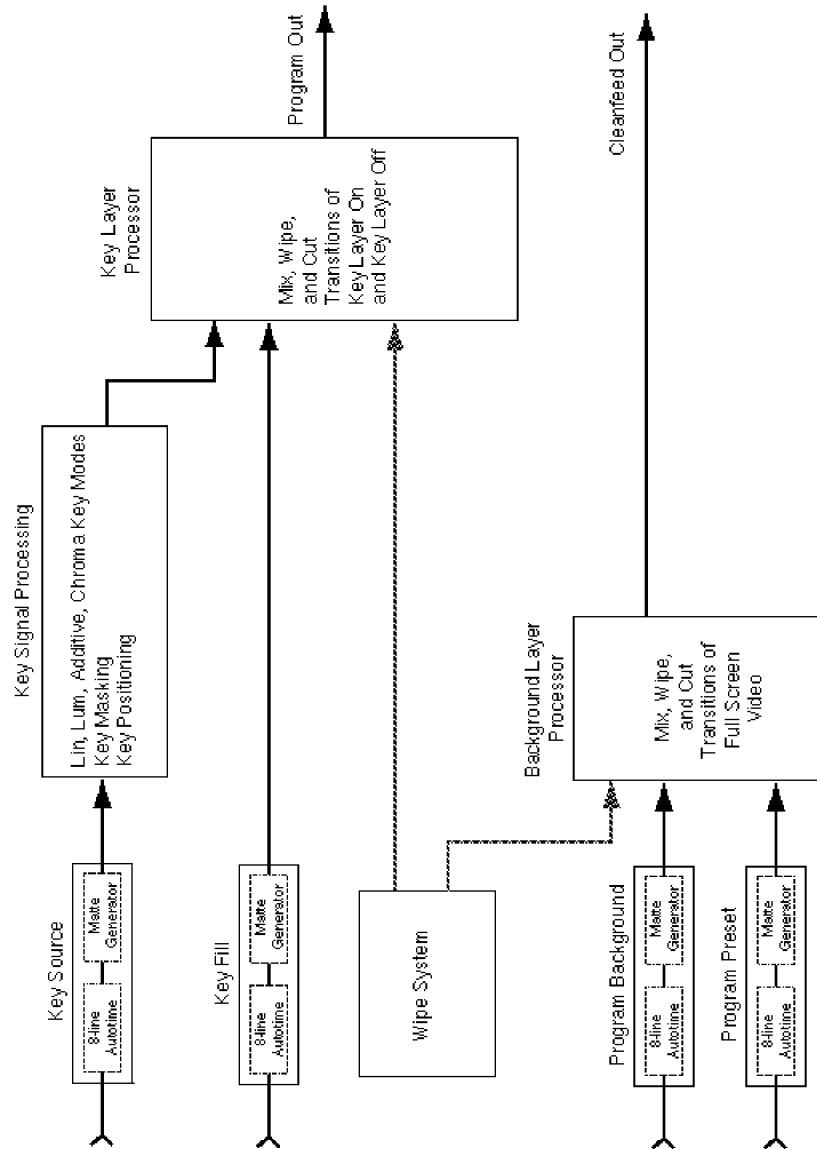

Catalyst CV Switcher/Vision Mixer Functional Block Diagram

Catalyst CV Installation

Remote Port Mode

This function defaults to GPI (Remote Port is not used).

Edit Port Mode

Catalyst CV may be controlled by a remote device such as an edit controller, if desired. Use this function to set the desired protocol.

- Off (if the Edit Port will not be used)
- Mac Remote (if you are using Ensemble's InMotion Macintosh software)
- Linc Peripheral (If you are using an Abekas A83 Production Switcher. You must select a LINC Address ID from 1-32)
- GVG 200 (Emulates the Grass Valley 200 protocol).

Network Status

This top level menu provides 3 network status choices as shown below:

- AppleTalk
- Ethernet
- Buffer Names

If you are using LocalTalk, select AppleTalk to identify and initialize the AppleTalk node.

To check your ethernet status, scroll to Ethernet . Press ENTER for the status of your ethernet connection. It should read Good Connection . If it reads No Transceiver or Bad Term , check your ethernet network for proper cables, connection, transceivers and terminations.

(NOTE: Be sure your workstation's ethernet port is active.)

Catalyst CV Installation

You can check the ethertalk net and node addresses by scrolling to Net and Node under this menu. You can also identify the ethertalk Zone under this menu.

To set your ethernet IP address, scroll to IP Address and enter the address in base 10 and press ENTER .

In the Buffer Names menu, each buffer must be assigned a unique name. Use the RIGHT and LEFT arrows to move between each digit in the name and the UP and DOWN arrows to select the characters.

This completes the front panel control menu setups for Catalyst. Refer to the next section for a full description of how to utilize the control panel.

Catalyst CV Installation

CATALYST CV CONTROL PANEL OPERATION

This section of the manual describes the operation of the Catalyst CV remote control panel. The control panel can be used to perform transitions, using either the lever arm or the transition pushbuttons. It also allows setup of all background, wipe and key parameters.

Getting Started

The control panel consists of three main sections:

- LCD display with pushbuttons and control knobs
- Numerical keypad pushbuttons and function keys
- Lever arm

The overall operation of each section of the control panel is explained below. Refer to the illustration of the control panel on the following page.

LCD Display, Pushbuttons and Control Knobs

The Liquid Crystal display (LCD) shows the menus for all the Catalyst CV control panel functions. The pushbuttons below the display allow you to select the background, fill, key, wipe, mask, shadow, buffer control, key type and engineering parameters, and allow you to move between the menus. The knobs above the display are enabled in certain menus to allow you to adjust parameters such as clip, gain, hue and positioning.

Each menu is explained in detail later in this section.

LCD Display Adjustment

The contrast and brightness of the Liquid Crystal Display (LCD) on the control panel can be adjusted if desired by following the steps below:

1. Press and hold down both the Home and Clear keys for both steps below.

Catalyst CV Control Panel Operation

2. Adjust the upper left knob above the control panel display for the desired contrast.
3. Use the second, third and fourth pushbuttons from the left under the display to adjust the brightness.
4. Release the Home and Clear keys.

Numerical Keypad and Function Buttons

The numerical keypad and the Set Rate, Save, and Restore pushbuttons allow you to enter values for the transition rate and assignment of memory registers.

The TRAN and CUT pushbuttons below the keypad enable either a Bkgd transition (mix, wipe or cut to selected preset video), a Key transition (mix, wipe, or cut selected key on) or both (change backgrounds and bring up key). Pushing the TRAN button will initiate the selected effect (mix or wipe) at the transition rate currently selected (shown in the top level Home menu in the LCD display). The CUT pushbutton will perform the transition selected immediately

When the Bkgd and/or Key pushbuttons are selected as the next transition, the green lights behind the pushbuttons and those in the cutouts next to them will light to indicate they have been selected.

Set Transition Rate

To set the rate of the transition when the TRAN button is pressed, select the Set Rate pushbutton at the top left of the numerical pushbuttons. The red light behind the pushbutton will light to show it is active. Select the rate for the transition in frames per second on the numerical keypad and press ENT. The rate will appear in the Home menu in the LCD display.

Catalyst CV Control Panel Operation

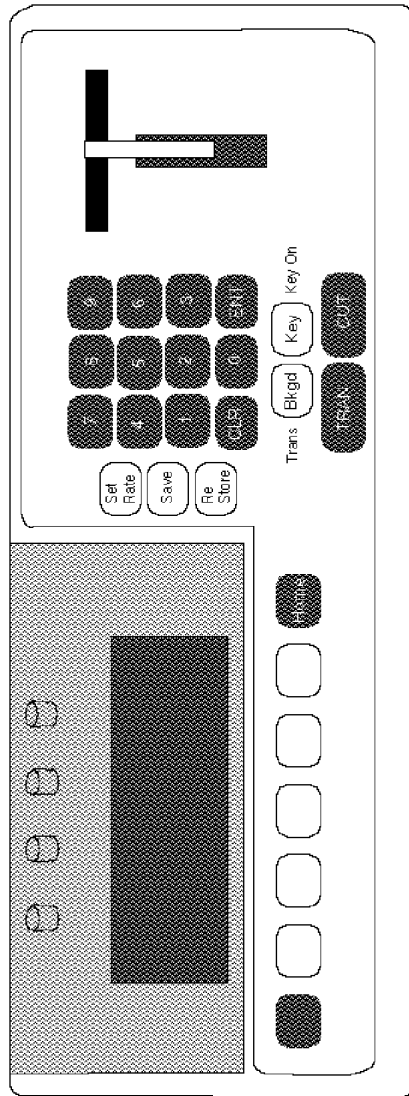

Catalyst CV Control Panel

Catalyst CV Control Panel Operation

Memory Registers

There are 100 memory registers available with the Catalyst CV. Storing information in a register is like taking a snapshot of the current Catalyst settings. The parameters memorized include transition type and rate, key type, clip and gain levels, and source selections for background, preset, key and fill.

To memorize a parameter, press the Save pushbutton to the left of the numerical keypad. The red light behind the pushbutton will light to show it is active. Select a register number (0-99) on the numerical keypad and press ENT.

To recall a register, press the Restore pushbutton, the register number on the keypad, then ENT. The red light behind the Restore pushbutton will light when it is active.

Lever Arm

The lever arm allows you to perform transitions in the same manner as the TRAN pushbutton. Moving the lever arm to either limit will perform the selected transition (Bkgd , Key or both) .

Menu Selections

Each of the menu functions is described in detail below.

Home Menu

The Home menu is the starting point for the menu functions available. The current status of the Catalyst CV setup will appear here. Press the Home pushbutton to return to this point at any time.

Functions available in the Home menu for standard 4:2:2 video mode (with optional External Mask disabled) are illustrated in the figure on the next page. (NOTE: If you are using 4:4:4 mode or

Catalyst CV Control Panel Operation

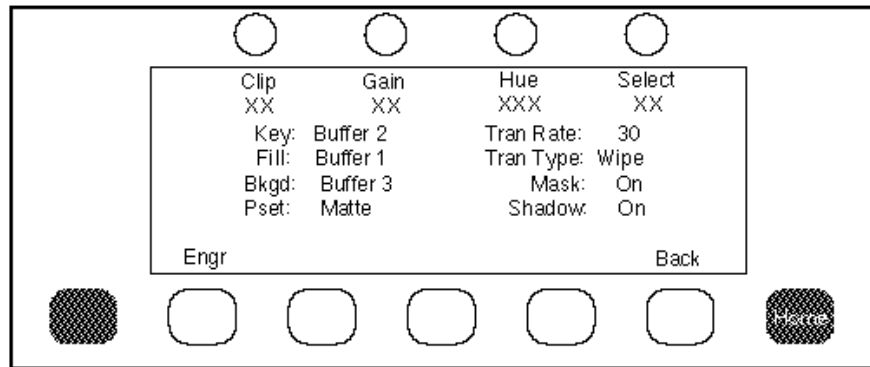
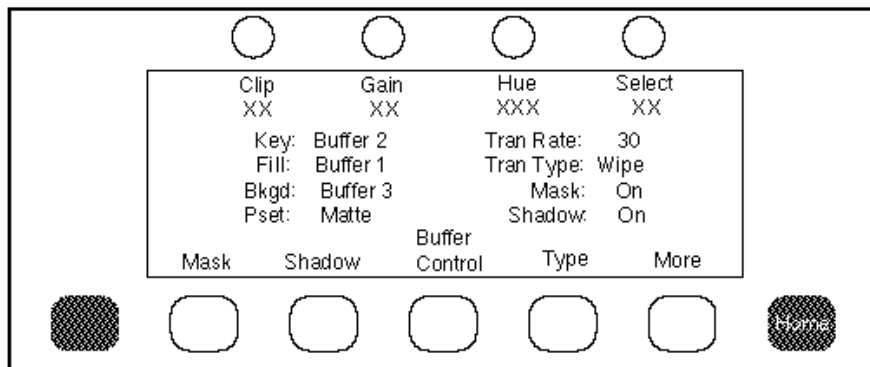
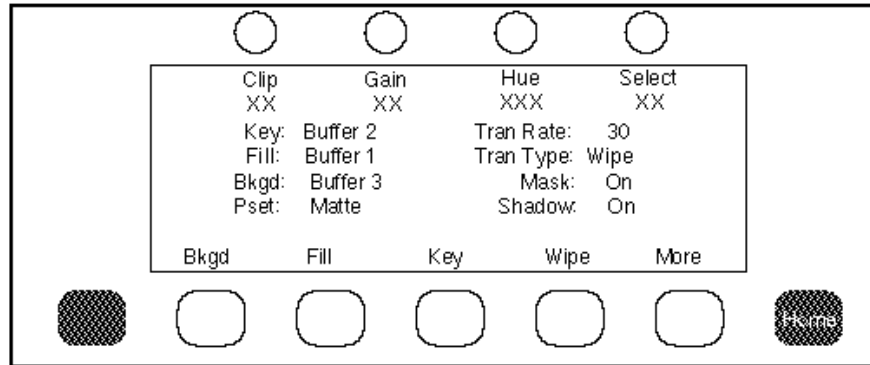

HOME Menu (Standard 4:2:2 Mode)

Catalyst CV Control Panel Operation

External Mask is enabled, the Home menu will be slightly different.)

The appearance of the Home menu depends on the operating mode chosen in System Configuration under the Eng menu. There are two modes of operation, either 4:2:2 video or 4:4:4 video. Also when the optional External Mask is enabled, the Home menu will change to reflect this operating mode. In this mode, the Wipe menu selection will change to Ext Mask as wipes are disabled when the external mask function is enabled. Refer to the Eng/System Configuration menu at the end of this section for more details.

To select a function, depress the pushbutton below the text and that function menu will appear in the display. To move to the next menu press More . At the end of the menu functions, select Back to return to the last menu.

The menu functions available are listed below. Each function is explained in detail in this section.

- Background
- Fill
- Key
- Wipe (When External Mask mode is OFF)
- Ext Mask (When External Mask mode is ON)
- Mask
- Shadow
- Buffer Control
- Type (refers to key type)

Background

This menu function allows you to choose any video input, buffer, color black or background matte for the current Background or Preset bus (next background). Select Bkgd and choose either the Background or the Preset Bus as shown below.

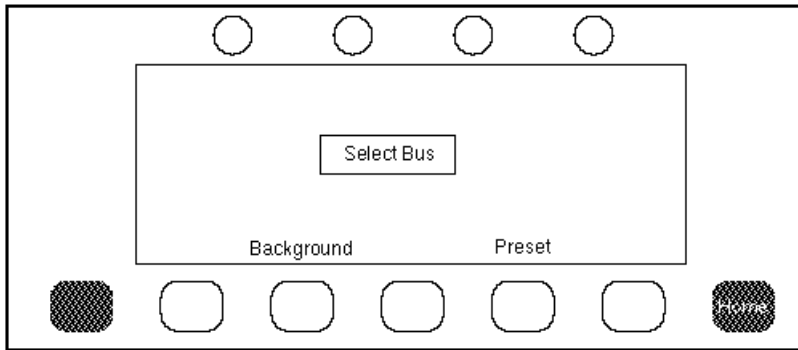

Select Bus Menu

Either selection will bring up the Bus Selection menu shown below. This menu allows you to choose the video source for the background. The Background Bus Selection will be illustrated here. The Preset Bus selections, if chosen, are identical.

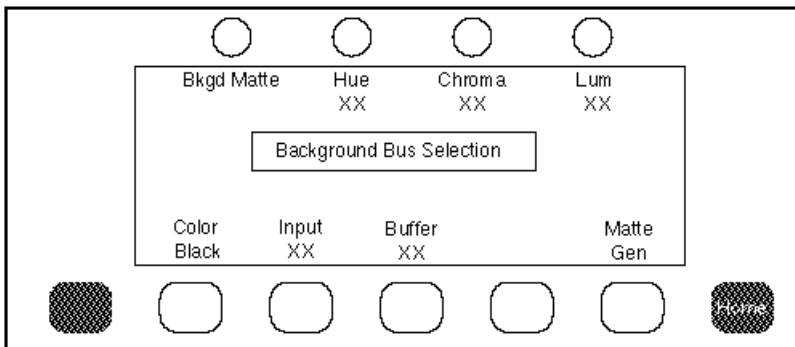

Background Bus Menu

Catalyst CV Control Panel Operation

When Color Black is selected the background will be color black.

When Input is selected, the menu will instruct you to Select an External Input . You may choose from external Input 1, Input 2, Input 3 or Input 4 for the new background as shown in the figure below. Press Done or Home when finished.

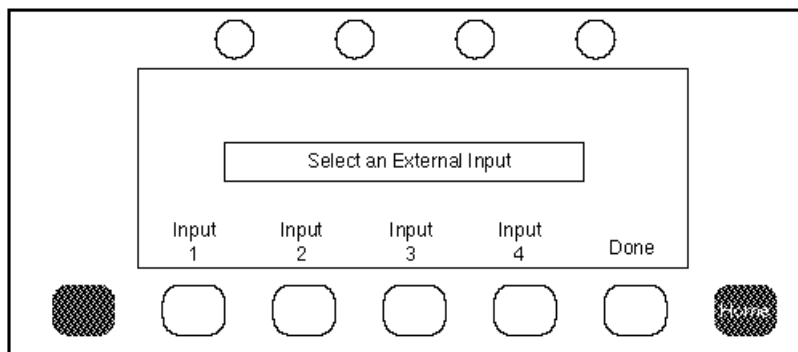

External Inputs Selection Menu

Catalyst CV Control Panel Operation

When Buffer is selected, the menu will read Select a SmartStore™ FrameBuffer . Choose from Buffer 1, Buffer 2, Buffer 3 or Buffer 4 for the new background illustrated below. Press Done or Home when finished.

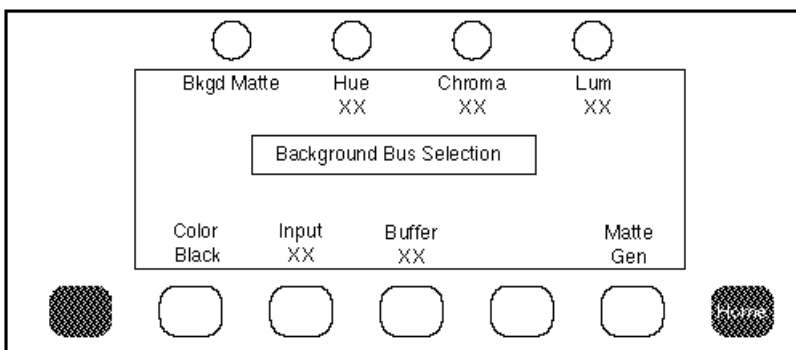

SmartStore Buffer Selection Menu

Selecting Matte Gen will enable the internal matte generator as the background. You may adjust the Hue, Chroma and Luminance knob controls at the top of the display for the desired matte as shown above.

Catalyst CV Control Panel Operation

Key Fill

Select any video input, buffer, color black or background matte for the key fill.

When Color Black is selected the key fill will be color black.

When Input is selected, the menu will instruct you to Select an external input . You may choose from external Input 1, Input 2, Input 3 or Input 4 for the key fill. Press Done when finished.

When Buffer is selected, the menu will read Select a Smart Store Buffer . Choose from Buffer 1, Buffer 2, Buffer 3 or Buffer 4 for the key fill. Press Done when finished.

Selecting Matte Gen will enable the internal matte generator as the matte fill. You may adjust the Hue, Chroma and Luminance knob controls at the top of the display for the desired matte.

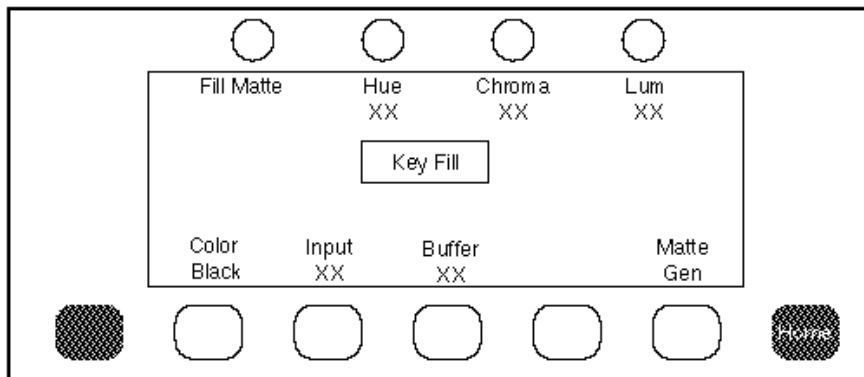

Key Fill Menu

Catalyst CV Control Panel Operation

Wipe

The Wipe control menu allows you to select the transition type (mix or wipe), the direction (Normal, Reverse, Nor/Rev), and the pattern type (0-27).

There are 28 pattern shapes to choose from. The pattern name and number are listed below:

Horizontal	0	Noise	14
Vertical	1	Corner UL	15
Hor Curtain	2	Corner UR	16
Vert Curtain	3	Corner LR	17
Hor Crossover	4	Corner LL	18
Diamond	5	Diagonal UL	19
Box	6	Diagonal UR	20
Circle	7	Diagonal LR	21
Matrix 8	8	Diagonal LL	22
Matrix 16	9	Wedge Up	23
Matrix 24	10	Wedge Down	24
Matrix 32	11	Wedge Left	25
Matrix 48	12	Wedge Right	26
Matrix 72	13	Wedge X-over	27

To enable a pattern, press the Pattern Select pushbutton. To return to the Home menu, press Back .

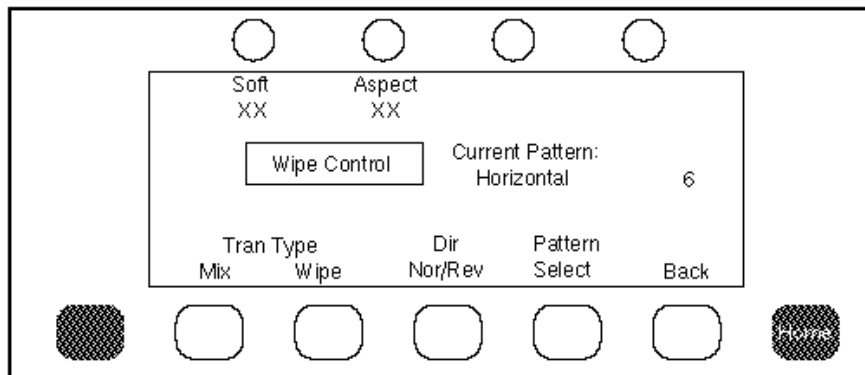

Wipe Menu

Catalyst CV Control Panel Operation

Ext Mask

The menu selection Ext Mask will appear in place of the Wipe menu selection when the external mask function is enabled under System Configuration in the Eng menu.

To enable the External Mask mode, go to the Catalyst Home menu and select More , then More again. This will take you to the Eng menu. Press Eng and select System Configuration . In this menu, enable the Ext Mask mode by pushing the button below it to change the selection from Normal to Live .

The External Mask option in Catalyst allows you to mask out undesirable parts of a dynamic (live) key using an externally generated mask signal. The external mask signal switches the key to full background wherever the external mask key signal is white. So, you can generate a black and white computer-based image to mask the parts of the live key you wish to appear as full background (the undesirable part of the key) and feed it to the Catalyst as the external mask signal.

For example, in the figures on the next page, the top two figures show the background and the live foreground image to be keyed in. However, there is a bookcase on the right edge of the key image that needs to be masked out of the scene. A black and white external mask key signal is created as shown, fed to Catalyst, then keyed into the scene. This allows the background to show through where the mask is white, masking the bookcase out of the final scene illustrated in the bottom figure.

Catalyst CV Control Panel Operation

BACKGROUND SCENE

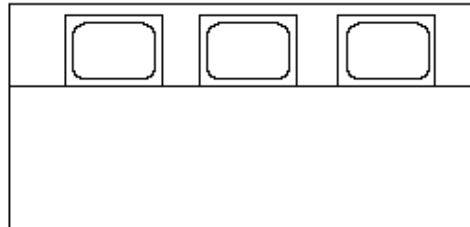

FOREGROUND IMAGE (BLUE SCREEN)

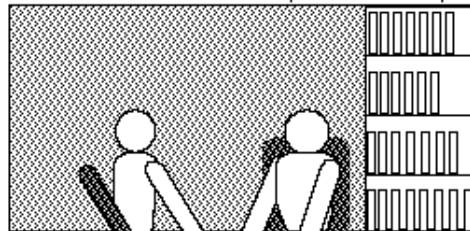

EXTERNAL MASK SHAPE

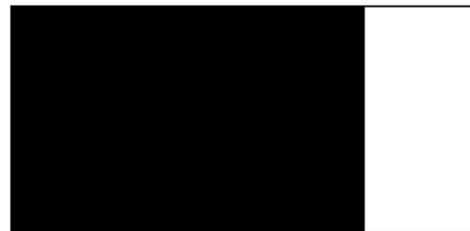

FOREGROUND KEYED INTO BACKGROUND
WITH MASK ENABLED

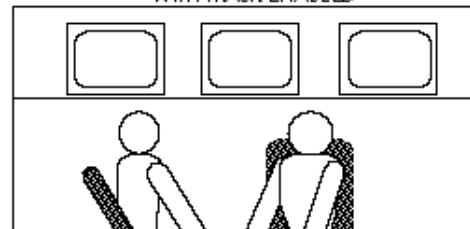

External Live Mask Example

Catalyst CV Control Panel Operation

When live mask is enabled in Catalyst, the external live mask signal is routed through the Preset Bus path, thus taking the place of the Preset Bus video. This means that the Preset Bus is disabled for normal operation and no background transitions can be executed. The key can only be cut on or off, not transitioned (no mix or wipe functions).

Enter the Ext Mask menu illustrated below to enable the mode and select the desired input source location for the external mask signal.

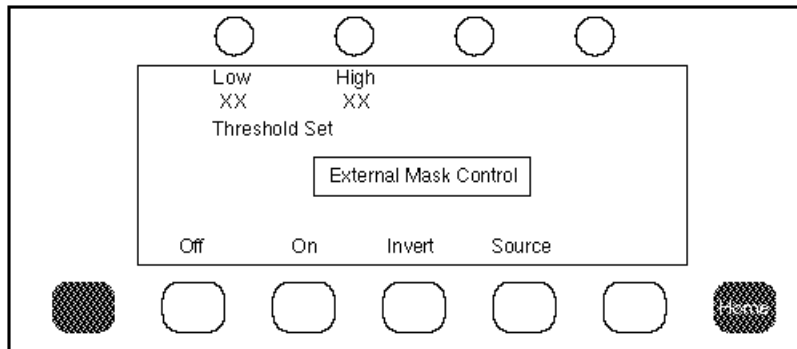

External Mask Menu

Select On to turn on the key or Off to disable it.

Select Invert to reverse the key.

Select Source to enter the Mask Bus Selection menu.

Choose your input from Color Black, Input (Input 1-4) or Buffer (Buffer 1-4). Make your selection based on the desired location of your external mask source input.

Catalyst CV Control Panel Operation

Return to the top level Ext Mask menu and adjust the high and low threshold levels of the mask signal with the High and Low controls at the top of the menu screen.

The Low control adjusts the black level of the mask signal. It should be set to slightly above the black level of the background.

The High control adjusts the white level of the mask (the amount of background that will show through) and should be set to slightly below the white level of the external mask.

The High and Low threshold adjustments will vary with the type of external mask key signal being using. Adjust these levels while observing the final key on a monitor for best results.

Catalyst CV Control Panel Operation

Mask

The key mask is a box shape and can be used to key part of a graphic or area of live video. The mask can be set for any area of the raster and adjusted very precisely to just one pixel (left and right) and/or one line (top and bottom) of video. The left, top, bottom and right parameters are adjusted using the top control knobs.

To enable the mask press Mask On. The Mask selection will be highlighted to indicate it is active as shown below. Adjust the sides of the mask as needed. You may also adjust the position by pixel or line number by setting the values below each knob.

The mask can be inverted (reversed) by selecting Invert. The Force mode can be used to apply the mask to a part of a key that you want to be keyed, regardless of the Clip and Gain settings.

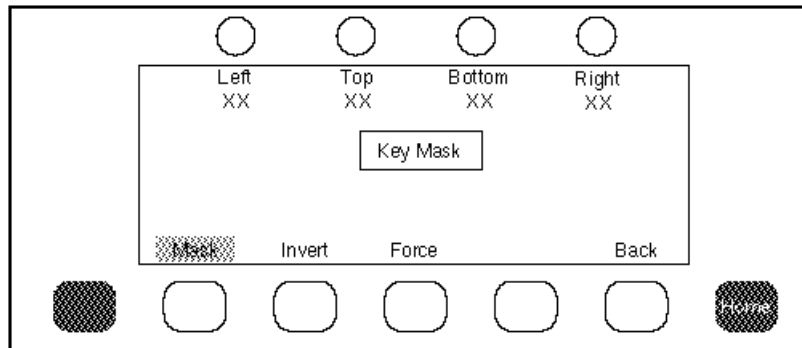

Mask Menu (Mask On)

Catalyst CV Control Panel Operation

Shadow

The variable drop shadow can be positioned horizontally and vertically as desired anywhere in the raster, even up and left of the key.

Enable the drop shadow by pressing Shadow . Position the drop shadow with the Hor and Vert knobs. The shadow density can be adjusted with the Density knob.

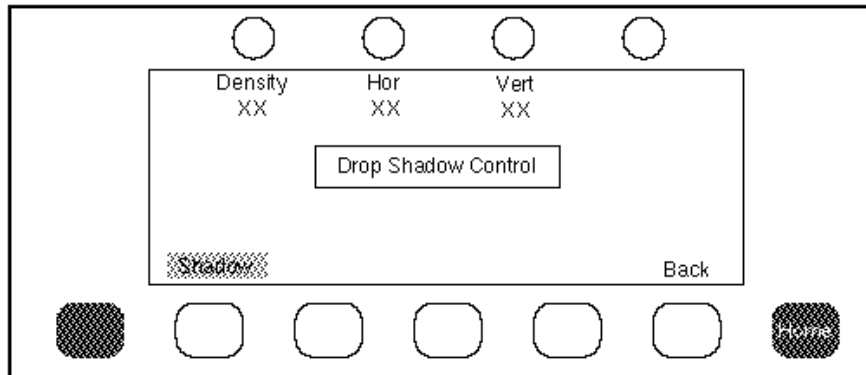

Shadow Menu (Shadow On)

Catalyst CV Control Panel Operation

Buffer Control

The Freeze/Unfreeze, input selection and test pattern parameters for the SmartStore buffers can also be chosen from the control panel. Select a buffer from the choices in the menu display as shown below.

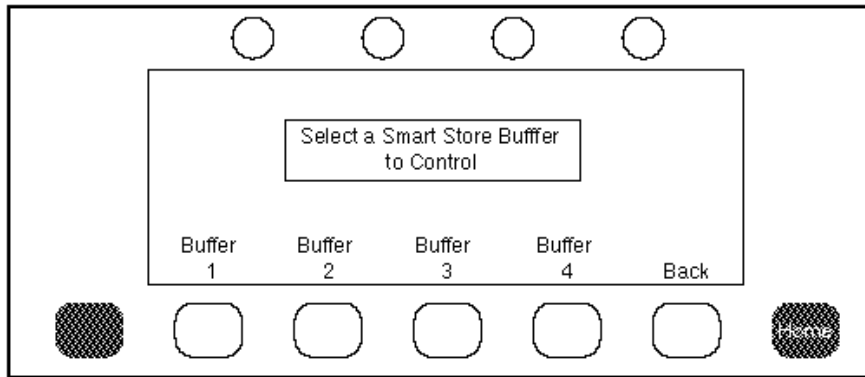

SmartStore Buffer Control Menu

For example, if Buffer 1 is selected, the menu in the top example on the next page will be displayed. Select Freeze to freeze the Buffer 1 video. Freeze will be highlighted to show it is active.

Push the Input Select pushbutton and the inputs available to the buffers will appear as shown in the middle figure on the next page. You may select from the following inputs:

- Inputs 1-4
- Buffers 2-4
- CatCV Program or Clean Feed video (CatCV Pgm or CatCV ClnFd)
- Test pattern (menu shown in the bottom figure). For a complete list of patterns, see the menu tree in Appendix A.

Catalyst CV Control Panel Operation

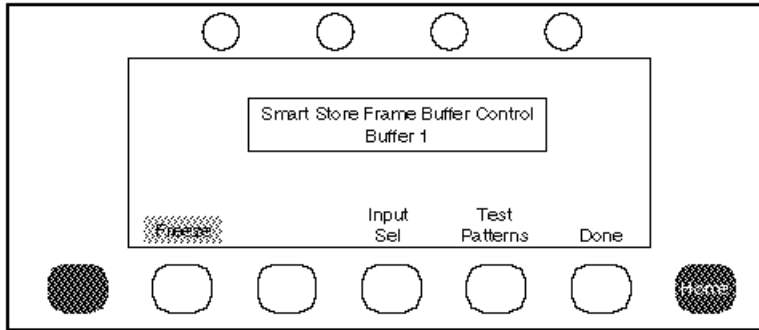

Buffer 1 Control Menu (Freeze On)

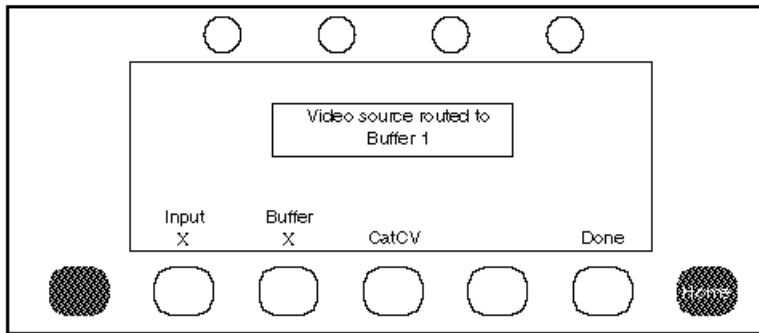

Buffer 1 Video Source Menu

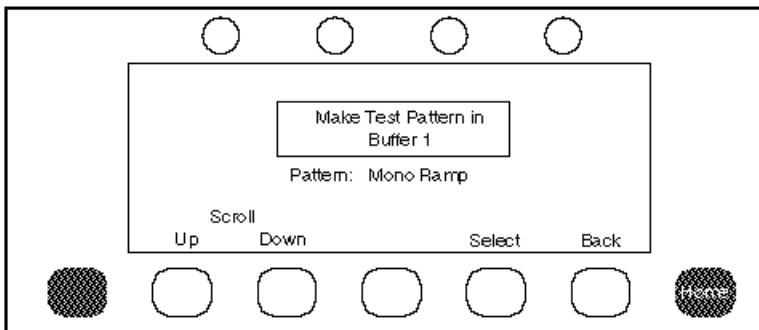

Make Test Pattern In Buffer 1 Menu

Catalyst CV Control Panel Operation

Key Type

Catalyst CV can execute Luminance, Linear, Additive and Chroma keys. Catalyst lets you select the sources for each key type so any key type can be a self key just by choosing the same source for both key and fill. Each key type is discussed below.

A Luminance key uses the lightest area of one video to cut the hole in the background. Edges can often look abrupt with a Luminance key. The amount of brightness is controlled with the Clip control knob.

A Linear key is one in which the key is multiplied against the foreground before the foreground is added to the background. This makes the fill a little bit narrower than the key and you might see a small dark line around the fill as a result. The key edge Blur and positioning can be used to minimize this effect. Linear keys are excellent for showing transparency and detail in key material.

A Chroma key is a self key as it uses the same source for key and fill automatically. A selected color is removed from the scene and filled with the key fill. This allows you to place an entirely different background behind an object.

An Additive key uses the key signal to cut a hole in the background (like a linear key) and it assumes the fill matches the key perfectly. The background and foreground were shaped by the same key. Catalyst's circuitry simply adds the two signals together.

One thing that differentiates an Additive key from other types of keys is that nothing in the fill is suppressed. If there is extraneous video information outside of the key area then another key type should be used, such as a Linear key.

Catalyst CV Control Panel Operation

Additive keys are excellent for keying computer generated graphics and character generator material where the edges are already shaped and there are no extra graphics elements that need to be eliminated by the key signal. The edging looks very smooth on an additive key.

To select the key type choose one of the key types shown in the menu below. For Luminance , Linear and Additive keys, adjust the Clip , Gain and Blur as desired.

Also, any key can be inverted (the background and fill reversed) by selecting the Invert pushbutton.

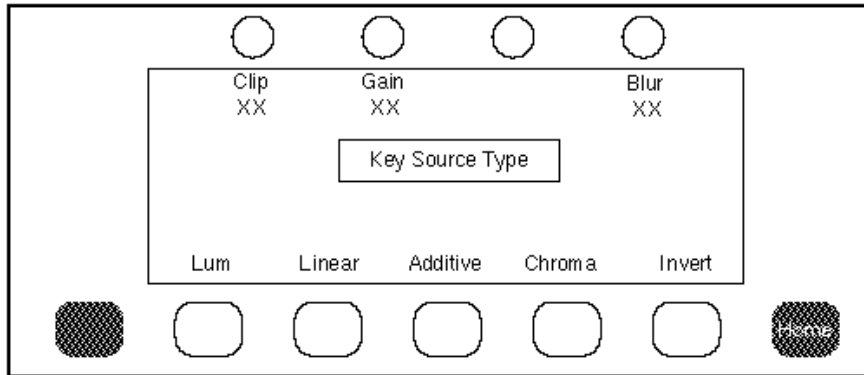

Key Type Menu

Catalyst CV Control Panel Operation

When Chroma Key is selected, the menu will appear as shown in the figure below.

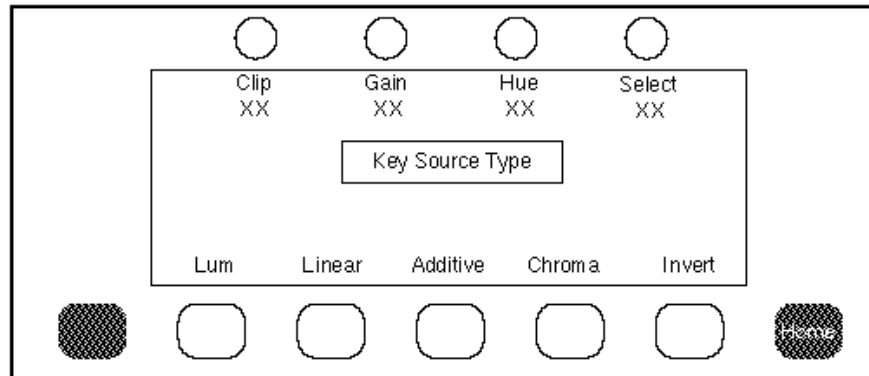

Chroma Key Menu

To set up a Chroma key, hold down the far left button under the display to enable the Show Key function. This puts the key into a black and white mode allowing you to adjust the Clip and Gain controls for the highest contrast between the foreground and background.

Use the Hue and Select controls to determine the color to key on (Hue) and the width of that color range (selectivity).

Engineering Setup

The Engr menu allows you to set up parameters for routing the Program to Output 1, System Configuration and a Help reference as shown in the menu below.

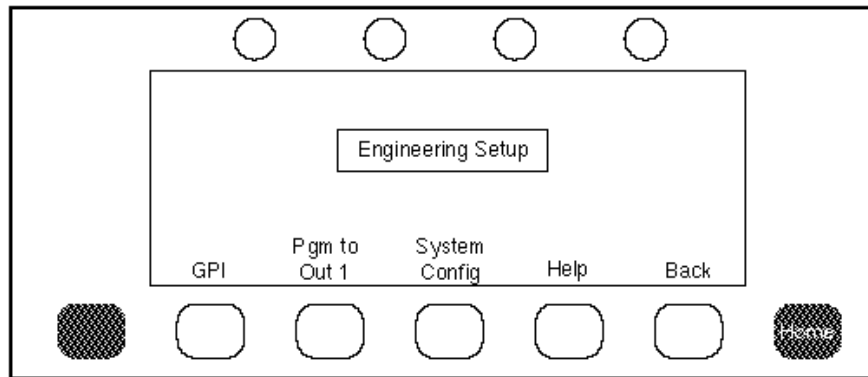

Engineering Menu

The GPI function is on and requires no selection.

Selecting Program to Output 1 routes the Catalyst Program video to Output 1 and can be useful in troubleshooting the system. Refer to the Troubleshooting section at the end of this manual

The System Configuration menu shown below lets you choose the Aspect ratio (4:3 or 16:9), the video Mode (4:2:2 or 4:4:4) and the status of the optional Ext Mask (Normal or Live). Use the pushbutton below each function to toggle between the selections.

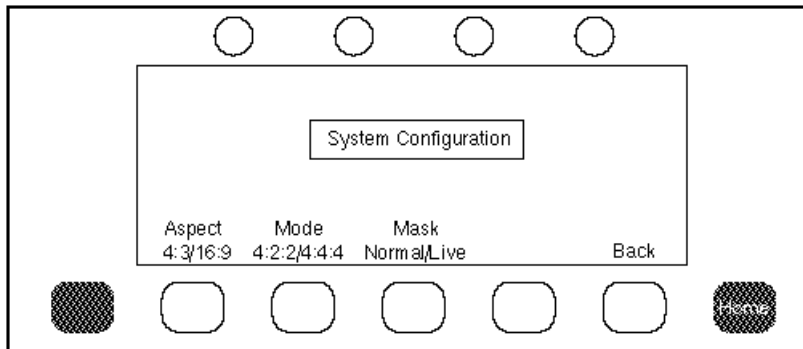

System Configuration Menu

If the 4:4:4 video mode is chosen, note that the Home menu changes to reflect how the 4:4:4 video is handled in Catalyst as shown in the top figure on the following page. Telecine applications are typical 4:4:4 examples.

When Ext Mask is in Normal mode, there is no external mask enabled and no change to operation. When Live is chosen, an external mask signal is routed to the Preset Bus and used to key out undesired artifacts. The Wipe menu selection in the Home menu will change to Ext Mask. Refer to the Ext Mask menu explanation earlier in this section for information and applications.

In the Eng menu, press the Help menu to access the Ensemble Designs contact information.

Catalyst CV Control Panel Operation

In 4:4:4 mode, the video from inputs 1 and 2 and inputs 3 and 4 are combined to handle the required color information. Only mix, wipe and cut background transitions are possible in this mode.

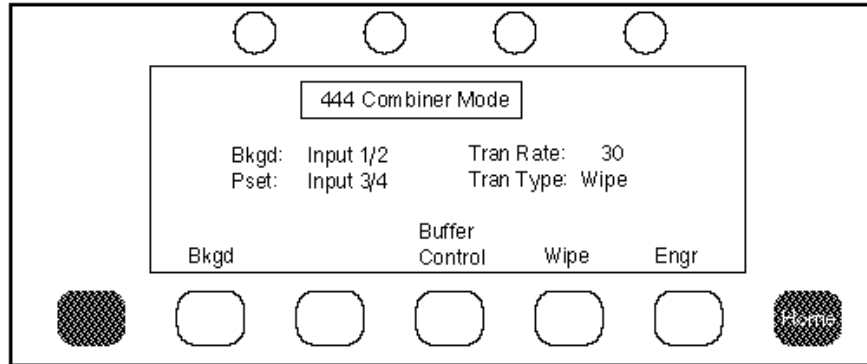

4:4:4 Mode Home Menu

The menu below shows the selections when Bkgd is chosen in the 4:4:4 Home menu. Note that inputs 1/2 or 3/4 will be linked automatically from A to B (Input 1=A, Input 2=B, Input 3=A, Input 4=B) to provide the preset selection.

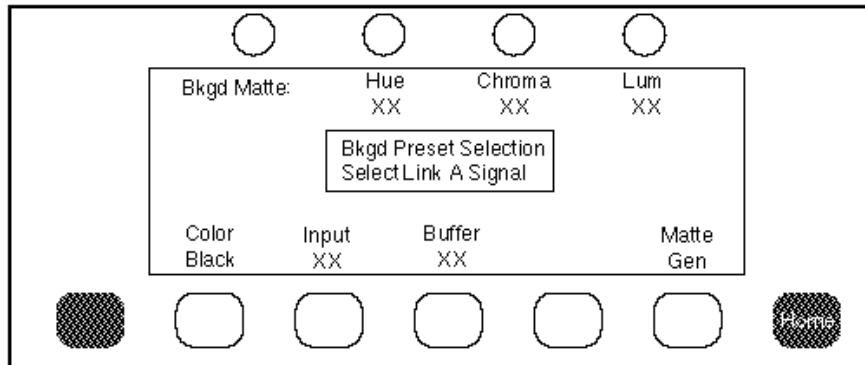

4:4:4 Mode Background Menu

Catalyst CV Control Panel Operation

CONTROL WITH SGI OR PC/NT APPLICATIONS

Catalyst CV can also be controlled by an SGI or PC/NT application through TCP/IP. The Ethernet Local Area Network feature of Catalyst CV provides a straightforward means to transfer images with Silicon Graphics and PC/NT workstations. Using standardized commands already in use with other networked video devices, full control of Catalyst functions and image transfers in both directions can be integrated into the SGI environment.

Under TCP/IP, Catalyst acts as a server. This allows a user at an SGI station to connect in the same manner used to access a central fileserver or DDR. Catalyst is given a user-assigned IP (Internet Protocol) address in the form 192.X.X.XX which provides a unique identification of the Frame Store on the network. The IP address for Catalyst is added to the SGI Network Hosts list so that it can be referenced by a meaningful device name ("cat" is used in the examples which follow).

In this section, user commands are shown in bolded text, system prompts and responses are shown in normal typeface.

Operational control of Catalyst is provided through the Unix `rlogin` (remote login) utility. The `rlogin` command lets you log into Catalyst just as you would any other server. `rsh` is also supported. When connected via `rlogin`, on-line help is provided on all of the commands available.

Images are transferred using the `rcp` (Remote Copy) utility. This command lets you transfer image files from a computer to Catalyst CV and from Catalyst CV to another computer. Both 8 bit YUV and 10 bit YUV files are accepted.

Catalyst CV Control with SGI or PC/NT Applications

Getting Started

Set up a new host on the SGI workstation for the Catalyst CV; it could be called "cat", as in the examples given in this section.

Check the workstation to see what IP addresses are available and set the Catalyst's address as needed from the Catalyst frame front panel, or just use the default address.

To set the Catalyst IP address, go to the Network Menu and arrow through to the IP address. Press the down arrow to get to the menu for setting a new address. The address is shown and entered in Base10. Press ENT when done.

r Commands

These are the commands supported by the Catalyst CV under the rlogin Unix Utility. Assuming that 'catcv' has been referenced to the IP address of the Catalyst in the /etc/hosts file of the user's machine, rlogin and rsh can be used with the commands below.

rlogin Usage

An rlogin connection to Catalyst is generally established as follows:

```
sgi % rlogin cat
```

```
Welcome to the Catalyst CV
```

```
cat%
```

At this point a direct, fulltime connection has been established between the user's keyboard and the Catalyst. Using the command set described below, the operator has complete control over crosspoint routing, buffer freeze, timing, and other system parameters. The 'cat%' prompt indicates that communication is with the Catalyst CV, and no longer with

Catalyst CV Control with SGI or PC/NT Applications

the unix shell itself. An rlogin session is concluded by exiting, logging out, or typing cntl-D.

rsh Usage

For ease of issuing single commands and construction of scripts these commands can be issued singly through the rsh (remote shell) function under Unix. As an example, the rsh invocation of the freeze off command to buffer 1 would be as follows:

```
sgi % rsh cat freeze off buffer 1
Buffer 1 freeze off
sgi %
```

Commands

config

Syntax: config

Displays the option configuration of the Catalyst indicating the number of SmartStore frame buffers installed, the number of inputs (two are standard, any more are options), and the number of outputs (two are standard, any more are options).

Example: Request the configuration.

```
cat% config
```

Configuration of this Catalyst is:

- 2 SmartStore(tm) Frame Stores
- 3 Serial Digital Inputs
- 2 Serial Digital Outputs

```
cat%
```

Catalyst CV Control with SGI or PC/NT Applications

?

Syntax: ?

Displays the commands available under rlogin.

Example: Let's get some info

cat% ?

Commands for the CatCV:

?	Display this menu
config	Display configuration of the CatCV
dm	Display the content of a specific memory location
exit	Exit remote login
freeze	Freeze a buffer
genlock	Display or set the genlock reference and line rate standard
help	Display this menu
hostaddress	Display the IP address of the CatCV
hostname	Display or set the hostname within the Catalyst
hphase	Display or set the horizontal timing
info	Display CatCV system information
logout	Exit remote login
mtp	Make Test Pattern in a Buffer
route	Queries and changes the CatCV's internal routing switcher
vphase	Display or set the vertical timing

cat%

Note: Due to the way Unix treats 'rsh cat ?', the 'help' invocation of this command must be used.

help

Syntax: help

Displays the commands available under rlogin. This is the same as the '?' command.

exit

Syntax: exit or cntl-D

Exits this invocation of rlogin, and returns to work station operating system. (Note: logout is an equivalent command).

Example: Let's exit!

cat% **exit**

sgi %

Note: This command is nonsensical under rsh since no login has actually taken place.

logout

Syntax: logout or cntl-D

Logout from CatCV and return to work station operating system.

(Note: exit is an equivalent command).

Example: Let's logout!

cat% logout

sgi %

Note : This command is nonsensical under rsh since no login has actually taken place.

freeze

Syntax: freeze [1 | 2 | frame | off] buffer
1|2|3|4

Display or change freeze status of one of four frame

Catalyst CV Control with SGI or PC/NT Applications

buffers. The freeze status can be freeze field 1, freeze field 2, freeze frame, or freeze off.

Example: Query freeze status of Buffer 1, response is that buffer 2 is in full frame freeze.

```
cat% freeze buffer 2
```

```
cat% freeze frame buffer 2
```

Example: Unfreeze Buffer 1 (in terse form).

```
catcv% f o b1
```

```
Buffer 1 freeze off
```

```
cat%
```

freeze 'space' function

Syntax: freeze space buffer 1|2|3|4

Turns on a single key mode to freeze and unfreeze a buffer. When the command is first issued this control mode is entered and a message is displayed prompting the user to use the space bar to toggle the freeze state of the buffer. The mode is exited by typing a carriage return.

Example: Enter freeze space mode for buffer 2 and toggle the freeze on and off, then exit.

```
cat% freeze space buffer 2
```

```
Hit space bar to freeze and unfreeze buffer 2
```

```
buffer 2 freeze off <space>
```

```
buffer 2 freeze frame <space>
```

```
buffer 2 freeze off <space>
```

```
buffer 2 freeze frame <cr>
```

```
cat%
```

Note: This function works only in rlogin, not rsh.

hostaddress

Syntax: hostaddress [address (dotted decimal)]

Displays the IP address of the Catalyst.

Example: Query the IP address

cat% hostaddress

Host Address of the Cat is: 192.0.3.216

cat%

hostname

Syntax: hostname [name - string]

Display or set the hostname within the Catalyst. This name is used only as the rlogin prompt. The hostname can be set to match the workstation's hostname file. This is particularly useful if multiple Catalysts are used on a common network.

Example: Change the host name to '601'.

cat% hostname 601

601%

hphase

Syntax: hphase buffer 1 | 2 | 3 | 4 [htiming val]

Set or display the horizontal timing value for the selected buffer.

Example: display H phase value of Buffer 2

cat% hphase b2

hphase buffer 2 is -162

Example: Set Buffer 1 Hphase to +24

cat% hphase b1 24

Catalyst CV Control with SGI or PC/NT Applications

vphase

Syntax: vphase buffer 1 | 2 | 3 | 4 [htiming val]

Set or display the vertical timing value for the selected buffer.

Example: display V phase value of Buffer 1

```
cat% vphase b1
```

```
vphase buffer 1 is 3
```

Example: Set Buffer 1 Vphase to +24

```
cat% vphase b1 24
```

```
vphase buffer 1 is 24
```

```
cat%
```

info

Syntax: info [-e -t -i]

Display Catalyst system information.

- e option provides information about Ensemble Designs

- t displays tcp connection parameters and status

- i displays ip connection parameters and status

Example: an example

```
cat% info -i
```

```
<ip connection parameters displayed here>
```

```
cat%
```

mtp

Syntax: mtp buffer [1 2 3 4] { pattern name }

This command causes a video test pattern to be created in the designated buffer. Valid pattern names are:

colorbar

crosshatch

safetitle

pulsebar

colorblack

Example: Cause crosshatch to appear in buffer 2

```
cat% mtp buffer 2 crosshatch
```

```
cat%
```

route

Syntax: route [source destination]

Queries and changes the Catalyst's internal routing switcher. When the command is invoked without any arguments, the entire state of the router is displayed. To make a crosspoint change, both a source and destination must be supplied.

The video sources are:

Input 1

Input 2

Input 3 (if option is installed)

Input 4 (if option is installed)

Buffer 1 (if option is installed)

Buffer 2 (if option is installed)

Buffer 3 (if option is installed)

Buffer 4 (if option is installed)

Catalyst CV Control with SGI or PC/NT Applications

The destinations are:

Output 1
Output 2
Output 3 (if option is installed)
Output 4 (if option is installed)
Buffer 1 (if option is installed)
Buffer 2 (if option is installed)
Buffer 3 (if option is installed)
Buffer 4 (if option is installed)

Because the SmartStore frame buffers in the Catalyst have both an input and an output, they are simultaneously sources and destinations. Input x and Output y correspond to the serial digital inputs and outputs on the Catalyst chassis.

This command supports a terse syntax, where Output 2 shortens to o2.

The Catalyst router is a fully populated x-y matrix, so any source can feed any destination.

Example:

- 1) Query router settings,
- 2) then connect Input 2 to Output 1
- 3) and connect Buffer 3 to Output 2 in terse mode

cat% **route**

Source	>>	Destination
Input 1		Buffer 1
Input 2		Buffer 2
Buffer 1		Buffer 3
Input 3		Buffer 4

Catalyst CV Control with SGI or PC/NT Applications

Input 3	Output 1
Buffer 2	Output 2
Buffer 3	Output 3
Input 1	Output 4

cat% **route input 2 output 1**

Source	>>	Destination
Input 1		Buffer 1
Input 2		Buffer 2
Buffer 1		Buffer 3
Input 3		Buffer 4
Input 2		Output 1
Buffer 2		Output 2
Buffer 3		Output 3
Input 1		Output 4

cat% **r b3 o2**

Source	>>	Destination
Input 1		Buffer 1
Input 2		Buffer 2
Buffer 1		Buffer 3
Input 3		Buffer 4
Input 2		Output 1
Buffer 3		Output 2
Buffer 3		Output 3
Input 1		Output 4

cat%

genlock

Syntax: `genlock [ref] [std]`

Display or set the genlock reference and line rate standard.

Ref can take on:

ref a

ref b

input 1

freerun

Std can take on:

525

625

Example: Set to Reference A genlock at 525 line rate

cat% **genlock ref a 525**

cat%

dm

Syntax: `dm [adr count]`

Displays contents of specified memory location(s).

The beginning address, `adr`, is interpreted as a hexadecimal value. The count, also in hex, specifies the number of bytes to display. Count may not exceed \$100, larger values will be automatically limited.

If the `adr` and `count` is omitted, the command will repeat the previous count, starting at the next location after the last `dm` command. This makes it easy to display a block of memory larger than \$100.

Note: This command is not for novices. It allows unrestricted access to the processor's full address

Catalyst CV Control with SGI or PC/NT Applications

space. It can disturb system operation if a memory mapped IO register is read out of sequence.

Additionally, since the full memory space is not used, it can trigger a bus error which is a fatal (though not necessarily tragic) circumstance. This command is provided for engineering purposes and it is described here only for completeness.

Example: Read \$20 bytes starting at location \$1F8B2

```
cat% dm 1F8B2 20
```

```
1F8B2 12 34 56 78 3B 8A 91 FC 9B 3D 84 91 37 BA  
CD 81
```

```
1F8C2 95 78 CD 9B 3D 84 91 37 3D 84 12 34 56 78  
38 B5
```

```
cat%
```

Function Control Commands

This section describes the commands to control Catalyst functions from the workstation. All commands must be preceded by `kc`. For a complete list of commands, `rlogin` and type `kc?`.

Transitions

Transition commands include the following:

kc trantype, tt

softcut, cut

cut, c

rate

nexttran, nt

tran, t

Catalyst CV Control with SGI or PC/NT Applications

For example, if you want to mix the key on, type:

kc tran key on

Routing Control

For controlling internal routing use the following commands:

kpgm	keyer program out
kpvw	keyer preview out
mat	internal matte
blk	color black
ka	keyer background A
kb	keyer background B
kf	key fill
ks	key source

For example, if you want to route Buffer 2 to the Key Fill, type:

r b2 kf

Key Control

The following commands control key functions:

ckhue	
clip	Adjust key clip
gain	Adjust key gain
key, k	
mask, m	Turn mask on and off
maskinv, m	Invert mask
maskpos, mp	
shadow, s	Turn shadow on and off
shadowp	Shadow position
keyinvert, kt	Invert key

Catalyst CV Control with SGI or PC/NT Applications

density, d	Adjust shadow density
keydelay, kd	
cksel	
keytype, kt	Select key type
keyunity	
maskmode	Select live or normal

Other Controls

The following commands control various background and other control functions:

bkgdmatte, bmt	
combiner, cm	
restore	Restore memory register
save	Save memory register

For example, to save memory register 20, type:

kc save 20

rcp Commands

Remote copy, rcp, is used in the Unix Shell for transferring images between the SGI and Catalyst CV.

Transferring YUV Pictures

To send a YUV picture from the SGI to buffer 1 in Catalyst, type this command in the shell:

rcp filename cat:001

To capture a picture in the Catalyst and copy it to the workstation in YUV format:

rcp cat:001 filename

Transferring RGB Pictures

fromyuv and toyuv are utilities used with the Catalyst for transferring RGB graphics. They are readily available and are often used with other video equipment, such as disc recorders. They are already installed on many workstations, usually kept in /user/sbin.

To change a picture that was captured in YUV (the Catalyst's format) to RGB (the SGI's format and the one you can easily view on the SGI screen):

fromyuv existing.filename new.filename

To change an RGB file to YUV:

toyuv existing.filename new.filename

Shell Scripts

Scripts can be created and iconized to simplify graphics transfers for both sending and capturing. Here are some examples:

SGI YUV File to CAT YUV Script

For sending YUV files to Catalyst, create a script with vi or jot or another editor. Give the script a name such as catbuf1:

```
jot catbuf1
```

In the text editor window type:

```
rcp $1 cat:001   where $1 is the temporary  
name for the picture
```

Then close the window. To check the permissions for this script:

```
ls -l catbuf1
```

Permissions may need to be changed to enable read and write in order to make the script executable:

```
chmod +x catbuf1   where chmod is change mode
```

Drag the icon onto the desktop or where ever is convenient. Drag and drop a YUV file onto the icon and the picture will automatically send to the Catalyst CV.

SGI RGB File to CAT YUV Script

For a script to drag and drop RGB files, follow the above steps and use this for the jot window:

```
toyuv $1 temp  
rcp temp cat:001
```

CAT YUV to SGI RGB Script

For capturing RGB files, create a script.

Choose a shortened command such as grab. Type in the Unix Shell:

```
jot grab
```

In the text editor window type:

Catalyst CV Control with SGI or PC/NT Applications

```
rcp cat:001 tem  
fromyuv temp $1
```

By typing grab filename in the Unix Shell, contents of Catalyst CV Buffer 1 will be captured and become a file in the workstation directory currently in use.

TROUBLESHOOTING

If you are experiencing problems with Catalyst CV operation, refer to the section below for some common troubleshooting tips.

Can't read LCD display on frame:

- Adjust LCD display by pressing and holding down the menu button then use the Up and Down arrow keys to adjust the light and dark contrast as desired.

Can't read LCD display on panel:

- Adjust control panel display for contrast and brightness. Press and hold down both the Home and Clear keys and adjust the upper left knob above the control panel display for the desired contrast. Or, use the second, third and fourth pushbuttons from the left under the display to adjust the brightness.

Frame display reads: "RU There to Panel?":

- Power frame off and back on.

Control panel says: "No Frame Connected":

- Be sure phone cable is plugged into one of the connectors on the dual LAN jack, not plugged into the diagnostic port. Check both the frame and the panel.
- Power the frame off and back on.
- Power the panel off and back on.

Green lines on the output or no output:

- Double check how the frame is genlocked. Is it locked to an analog reference or to the digital input? Now check the Genlock and Timing menu on the frame. Be sure it is set correctly.

Troubleshooting

No output:

- Be sure output #1 is connected to your monitor. Double check that the Catalyst program out is routed to output #1. To do this:

Press the Home button on the panel to return to the Home menu.

Press, More .

Press More again.

Press Engr .

Then press Prgm to Out1 .

- Be sure the background that is selected is a real signal. If you are using input 1 as the background, is there something connected to input 1?

Catalyst will only mix, but I want it to wipe:

- Press the Home button on the panel to return to the Home menu. Press the button labeled Mix. Now select Wipe by pressing the button labeled Wipe.

PRODUCT SPECIFICATIONS

Hardware

Base unit includes MultiBuffer DS-1 (no SmartStore™ Buffers) with internal Catalyst CV keyer module

Hardware Options:

External Mask

Tabletop Control Panel

Video Inputs

Standard: 2 Serial Digital SMPTE 259M inputs with reclocked active loopback outputs. 8-line autotime window or infinite when external input is passed through SmartStore FrameBuffer.

Optional: 2 additional inputs

Video Outputs

Standard: 2 routable output channels, 2 buffered outputs each, Serial Digital SMPTE 259M

Optional: 2 additional outputs

Framebuffers

Up to 4 SmartStore™ framebuffers are optional.

Ethernet

TCP/IP and Appletalk

10 Base 2 and 10 Base T, Upgradable to 100 Base T

Internal Format

10 Bit ITU-R 601 with 16 bit internal processing

16:9 mode selectable

4:2:2 or 4:4:4 mode selectable

4:4:4 mode for background transitions only

Product Specifications

Serial Interface

RS-422, DB 9 Connector, GV100/200 emulation

Genlock and Timing

Genlock reference selectable between 2 analog reference inputs or digital video input #1

525/625 selectable

Mechanical and Power

19" Wide, 1.75" High, 17" Deep;
483 Wide, 44.5 High, 432 mm Deep

Weight 12 lbs; 5.5 kilos

100-230 VAC

50/60 Hz

60VA

CE Compliant

Index

10BaseT (See also Ethernet)

Connection, 12

4:4:4 mode, 49

? (help command), 54

—A—

Analog Reference A or B, 8

AppleTalk, 22

Applications, 3

Networking with Computer Workstations, 5

Standalone Switcher/Keyer, 3

Telecine Frame Reference, 4

Aspect Ratio Menu, 48

—B—

Background Menu, 31

backplane

Illustration, 7

bkgdmatte command, 65

blk command, 64

Blur (key), 45

Buffer Control Menu, 42

Buffers (SmartStore)

As Background, 33

Control, 16

Make Test Patterns, 16

Make 422 Patterns, 16

Make 444 Patterns, 16

Set Pattern IDs, 17

Set Default, 18

Description, 8

Freeze Control, 18

Timing, 18

—C—

CAT YUV to SGI RGB Script, 67

Catalyst CV Combiner module, 1

Catalyst IP address, 52

Chroma control (key), 34

Chroma Key

Definition, 44

Setup, 45

ckhue command, 64

cksel command, 65

Clip (key), 45

clip command, 64

combiner command, 65

Commands (Unix), 53

Computer Network Connections, 12

config, 53

Control Panel

Menu Selections, 28

Control Panel

Connection, 12

LCD Display, Pushbuttons and Control Knobs, 25

Menu Selections

Background, 31

Buffer Control, 42

Eng, 47

Ext Mask, 36

Home, 28

Key Fill, 34

Index

- Key Type, 44
- Mask, 40
- Shadow, 41
- Wipe, 35
- Operation, 25
- Overview, 2
- Troubleshooting, 69
- cut command, 63
- CUT pushbutton, 26

- D—
- DDR, 4
- density command, 65
- Diagnostic Port, 12
- Digital Input #1 (sync reference), 8, 11
- dm (display memory) command, 62

- E—
- Edit Port Mode, 22
- Editor Port, 11
- Engineering Setup Menu, 47
- Ethernet
 - Connections, 12
 - Network Status Menu, 22
 - Setup, 13
- ethertalk, 23
- exit command, 55
- Ext Mask Menu, 38
- Ext Mask Option, 36
 - adjusting, 39
 - example of application, 36
 - Live/Normal Modes, 48

- F—
- FORCE (Mask), 40
- frame electronics, 7
- Freerun, 11
- Freerun (sync reference), 8
- freeze 'space' function, 56
- Freeze (Buffers), 18
 - control, 18
- freeze command, 55
- Front Panel Controls (Frame)
 - Menu Tree, 15
 - Menus, 15
 - Operation, 15
- Function Control Commands, 63

- G—
- Gain (key), 45
- gain command, 64
- Genlock & Timing, 19
- genlock command, 62
- GPI, 13, 22
 - Pinouts, 13
 - Specifications, 14

- H—
- H Timing
 - Buffers, 18
- help command, 55
- Help menu, 48
- High Threshold Control (Ext Mask), 39
- Home Menu (422), 28
- Home Menu (444), 48

-
- hostaddress command, 57
 - hostname command, 57
 - hphase command, 57
 - Hue (chroma key), 46
 - Hue control (key), 34

 - I—
 - independent mode (analog reference), 10
 - connection, 11
 - info command, 58
 - Inputs (serial digital), 7
 - INSTALLATION, 7
 - INVERT (Mask), 40

 - J—
 - Jumpers (analog reference), 10

 - K—
 - ka command, 64
 - kb command, 64
 - kc trantype, 63
 - key command, 64
 - Key Control commands, 64
 - Key Fill Menu, 34
 - Key Type Menu, 44
 - keydelay command, 65
 - keyinvert command, 65
 - keytype command, 65
 - keyunity command, 65
 - kf command, 64
 - kpgm command, 64

 - kpvw command, 64
 - ks command, 64

 - L—
 - LCD Display Adjustment
 - Control Panel, 25
 - Front Panel (Frame), 15
 - Lever Arm, 28
 - Line Standard, 19
 - Linear key, 44
 - logout command, 55
 - loop-through mode (analog reference), 10
 - connection, 11
 - Low Threshold Control (Ext Mask), 39
 - Luminance control (key), 34
 - Luminance key, 44

 - M—
 - Make 422 Patterns, 16
 - Make 444 Patterns, 16
 - Make Test Patterns, 16
 - mask command, 64
 - Mask Menu, 40
 - maskinv command, 64
 - maskpos command, 64
 - mat command, 64
 - Matte Gen
 - Background, 33
 - Key Fill, 34
 - Memory Registers, 28
 - Mode Menu (4:2:2 or 4:4:4), 48

Index

- mtp (make test pattern) command, 59
- MultiBuffer DS-1, 1, 15

- N—
- Network Status, 22
- Networking with Computer Workstations, 5
- nexttran command, 63
- Numerical Keypad and Function Buttons, 26

- O—
- Outputs (serial digital), 7
- OVERVIEW, 1

- P—
- Power specifications, 7, 72
- Product Specifications, 71
 - Ethernet, 71
 - Framebuffers, 71
 - Genlock and Timing, 72
 - Hardware, 71
 - Internal Format, 71
 - Mechanical and Power, 72
 - Serial Interface, 72
 - Video Inputs, 71
 - Video Outputs, 71

- R—
- r Commands, 52
- rate command, 63
- rcp (Remote Copy), 51
- rcp Commands, 66
- Reference Inputs (sync), 8
- Remote Port Mode, 22
- restore command, 65
- rlogin, 51
- rlogin Usage, 52
- route command, 59
- Router Control, 19
- Routing Control commands, 64
- rsh, 51
- rsh Usage, 53

- S—
- save command, 65
- Select (chroma key selectivity), 46
- Set Default, 18
- Set Pattern IDs, 17
- Set Transition Rate, 26
- SGI or PC/NT Application Control, 51
- SGI RGB File to CAT YUV Script, 67
- SGI YUV File to CAT YUV Script, 67
- shadow command, 64
- Shadow density, 41
- Shadow Menu, 41
- shadowp command, 64
- Shell Scripts, 66
- Show key, 46
- SmartStore, 4, 42, 53, 60
- softcut, 63
- Standalone Switcher/Keyer, 3

sync reference, 8
System Configuration Menu, 48

—T—

TCP/IP, 51
Telecine Frame Reference, 4
Thinnet (10Base2), 12
Thinnet BNC Connection, 13
 Connections, 13
tran command, 63
TRAN pushbutton, 26
Transferring RGB Pictures, 66
Transferring YUV Pictures, 66
Transition Commands, 63
TROUBLESHOOTING, 69

—V—

V Timing
 Buffers, 18
vphase command, 58

—W—

Wipe Menu, 35
Wipe Patterns, 35





SGI YUV File to CAT YUV Script67
CAT YUV to SGI RGB Script67
TROUBLESHOOTING69
PRODUCT SPECIFICATIONS71
INDEX73
APPENDIX A - Catalyst CV Front Panel Menu Tree	

