

**AVENUE**

Avenue™ signal integration system

# Model 5155 Dual Analog Video and AES DA Data Pack

**ENSEMBLE**

D E S I G N S

Revision 1.1 SW v2.0.0

This data pack provides detailed installation, configuration and operation information for the **5155 Dual Analog Video and AES Distribution Amplifier (DA)** as part of the Avenue Signal Integration System.

The module information in this data pack is organized into the following sections:

- Module Overview
- Applications
- Installation
- Cabling
- Module Configuration and Control
  - Front Panel Controls and Indicators
  - Avenue PC Remote Control
  - Avenue Touch Screen Remote Control
- Troubleshooting
- Software Updating
- Warranty and Factory Service
- Specifications

## MODULE OVERVIEW

The 5155 Dual Analog Video /AES DA module provides analog distribution of composite video signals, NTSC and PAL and AES audio. The 5155 is a dual distribution amplifier with two inputs; each input distributed to four outputs.

Input signal validity is displayed locally and can be monitored through the Avenue remote control options. Gain can be adjusted locally as well as remotely. Remote control is accessed via the optional Avenue Touch Screen Control Panel and Avenue PC Control Applications.

Each input signal passes through an input buffer circuit then goes on to the gain adjust circuitry as shown in the block diagram below. Overall gain can be adjusted locally with the trim pot on the module front panel or remotely with one of the remote applications as explained in the **Front Panel Controls and Indicators** section of this data pack.

Power is derived from the  $\pm 12$  volt frame power. It is regulated to the required +5 volts for the module by on-board regulator. The module is fused with a resettable fuse device. If the fuse opens due to an overcurrent condition, the module will lose power. After pulling the module, the fuse will reset automatically requiring no replacement fuse.

The on-board CPU can monitor and report the module ID information (slot location, software version and board revision) and signal presence detection which can be reported by the optional frame System Control module to the optional interfaces available.

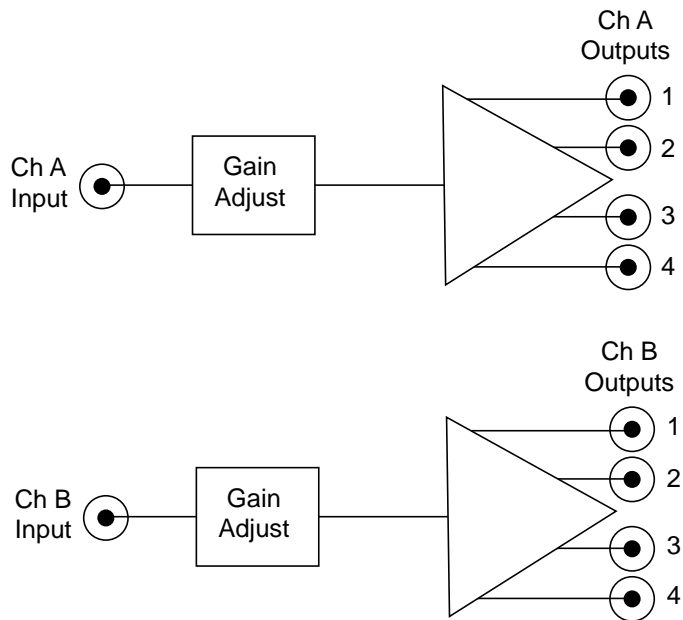

5155 Dual Analog Video DA Functional Block Diagram

## APPLICATIONS

As shown in the example below, the 5155 DA can be utilized to distribute master reference sources throughout a facility. The master reference genlock signals are inserted into the 5155 Ch A and Ch B inputs then distributed to four outputs each. The Avenue remote control system can be set up to report an alarm if there is a loss of the house reference.

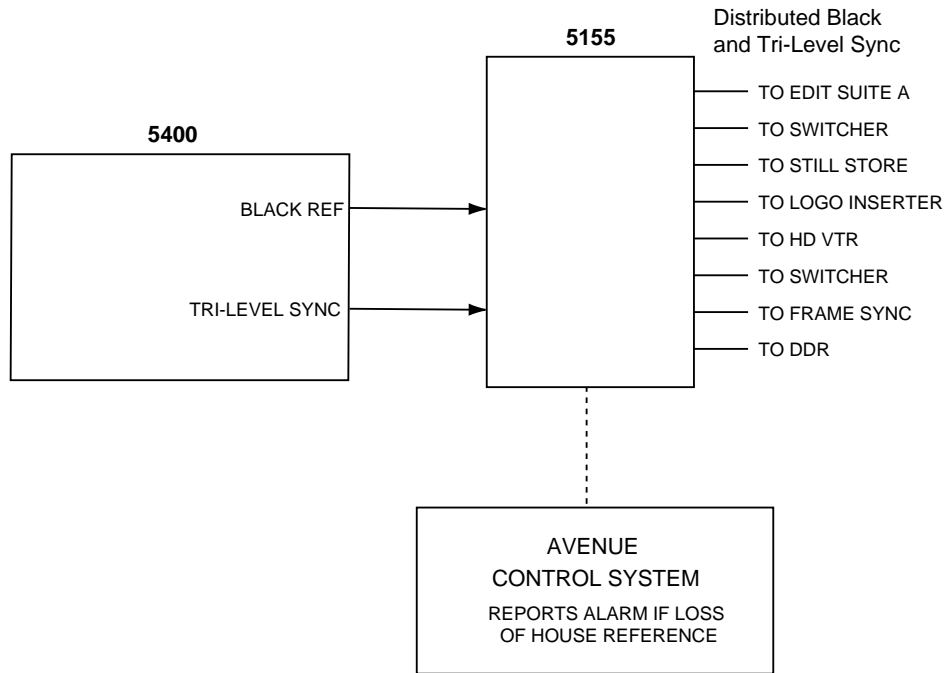

**5155 Genlock Distribution Application**

## INSTALLATION

Plug the 5155 module into any one of the slots in the 1 RU or 3 RU frames and install the plastic overlay provided onto the corresponding group of rear BNC connectors associated with the module location. Note that the plastic overlay has an optional adhesive backing for securing it to the frame. Use of the adhesive backing is only necessary if you would like the location to be permanent and is not recommended if you need to change module locations. This module may be hot-swapped (inserted or removed) without powering down or disturbing performance of the other modules in the system.

## CABLING

Refer to the 3 RU and 1 RU backplane diagrams of the module below for cabling instructions. Note that unless stated otherwise, the 1 RU cabling explanations are identical to those given in the 3 RU diagram.

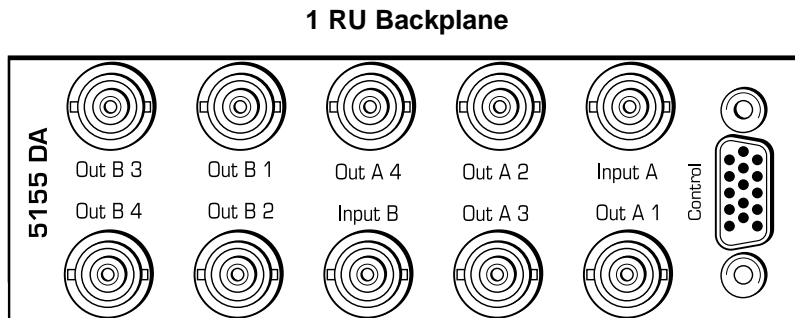
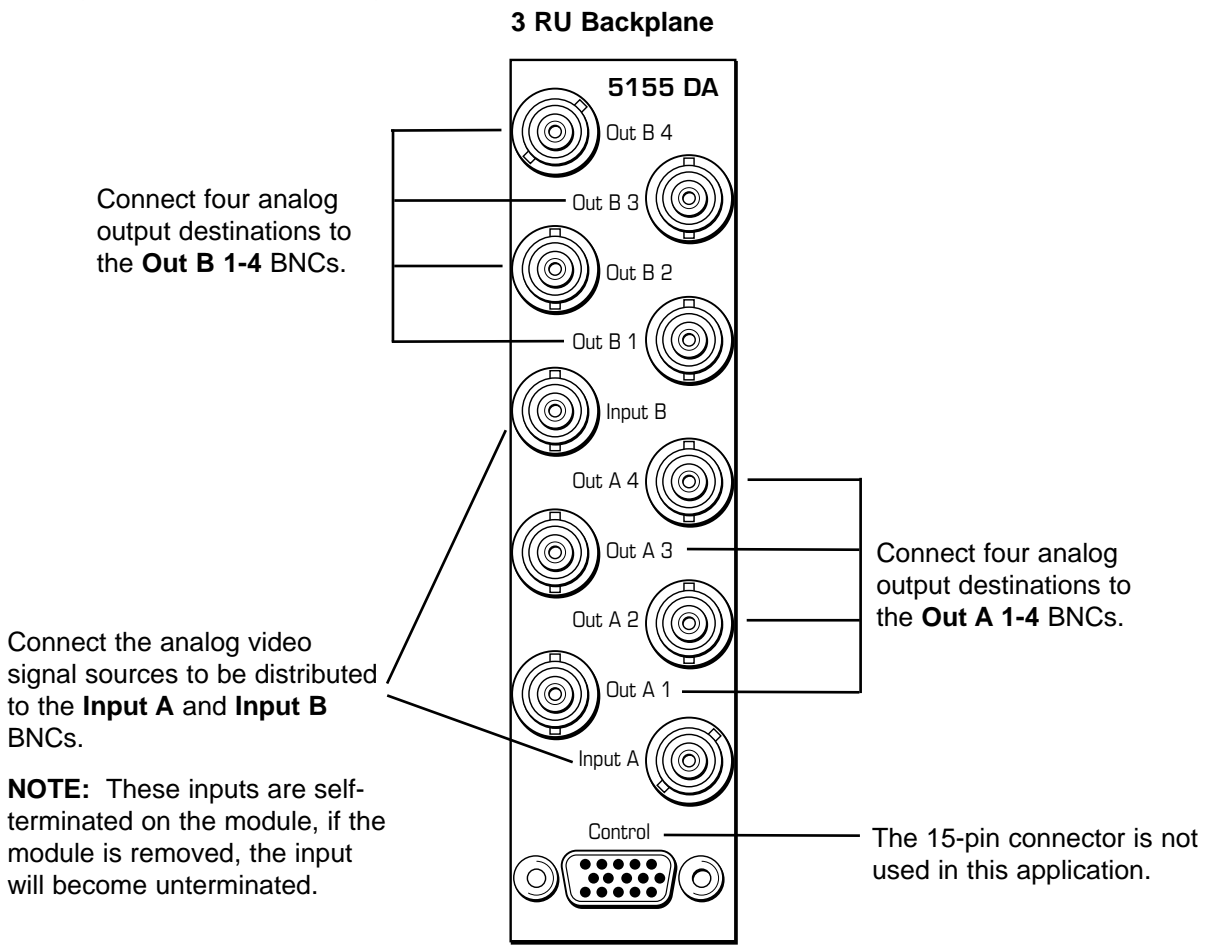

## MODULE CONFIGURATION AND CONTROL

The parameters for each Avenue module must be configured after installation. This can be done remotely using one of the Avenue remote control options or locally using the module front panel controls. Each module has a **REMOTE/LOCAL** switch on the front edge of the circuit board which must first be set to the control mode you will be using.

The configuration parameter choices for the module may differ between **Remote** and **Local** modes. In **Remote** mode, the choices are made through software and in general, allow more selections. The **5155 Parameter Table** below summarizes and compares the various configuration parameters that can be set remotely or locally and the default/factory settings. It also provides the default User Levels for each control. These levels can be changed using the Avenue PC application.

If you are not using an remote control option, the module parameters must be configured from the front panel switches. Parameters that have no front panel control will be set to a default value. The **Local** switches are illustrated in the **Front Panel Controls and Indicators** section following the **5155 Parameter Table**.

Avenue module parameters can be configured and controlled remotely from one or both of the remote control options, the Avenue Touch Screen or the Avenue PC Application. Once the module parameters have been set remotely, the information is stored on the module CPU. This allows the module be moved to a different cell in the frame at your discretion without losing the stored information. Remote configuration will override whatever the switch settings are on the front edge of the module.

For setting the parameters remotely using the Avenue PC option, refer to the **Avenue PC Remote Configuration** section of this document.

For setting the parameters remotely using the Avenue Touch Screen option, refer to the **Avenue Touch Screen Remote Configuration** section of this data pack following Avenue PC.

**5155 Parameter Table**

CONTROL	LOCAL	REMOTE	DEFAULT	USER LEVEL
<b>Gain A/Gain B</b>	90-110%	90-110 %	100%	Level 2

## Front Panel Controls and Indicators

Each front edge indicator and switch settings are explained in the diagram below:

**In A OK/In B OK green LEDs:**  
**ON** indicates presence of valid analog video signal (meets NTSC or PAL sync specifications).  
**OFF** indicates sync signal is not present or invalid (does not meet NTSC or PAL sync specifications).

**GAIN A/Gain B Adjustment:**  
Adjust gain equally for all four analog outputs for each channel.

**Pwr green LED:**  
Indicates the presence (**ON**) or absence (**OFF**) of power (+5V).

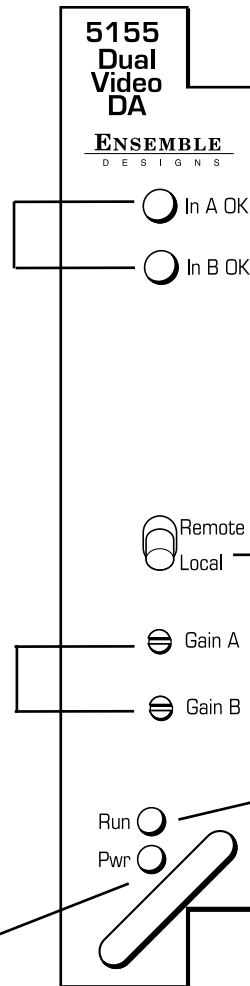

**Remote/Local switch:**  
Set to the mode you will be using.

**CPU green LED:**  
**OFF:**  
A power fault or halted CPU  
**ON:**  
A halted CPU  
**FAST BLINK:**  
CPU Run error  
**SLOW BLINK:**  
System OK. (If SPI control is active from the main frame System Control Module, all **Run** indicators will be synchronized).

## Avenue PC Remote Configuration

The Avenue PC remote control menus for this module are illustrated and explained in this section. Refer to the **5155 Parameter Table** for a summary of available parameters that can be set remotely through the menus illustrated. For more information on using Avenue PC, refer to the Avenue PC Control Application Software data pack that came with the option.

Parameter fields that are grayed out can indicate one of the following conditions:

- An option is not installed.
- The function is not active.
- The module is locked.
- The User Level set with Avenue PC is not accessible from the current User Level.

### 5155 Avenue PC Menus

In the **Chan A** menu shown below, set the following parameters:

- **Gain A** - set the gain of the analog output video to the desired setting (90-110%). Select the **Default** button to return to the factory default.

The following indicator is available in this menu:

- **Signal A** - will indicate the input signal status of the module and will display **No Input**, **525/NTSC**, **625/PAL**, **AES Audio**, or **Tri-Level Sync**.



In the **Chan B** menu shown below, set the following parameters:

- **Gain B** - set the gain of the analog output video to the desired setting (90-110%). Select the **Default** button to return to the factory default.

The following indicator is available in this menu:

- **Signal B** - will indicate the input signal status of the module and will display **No Input**, **525/NTSC**, **625/PAL**, **AES Audio**, or **Tri-Level Sync**.

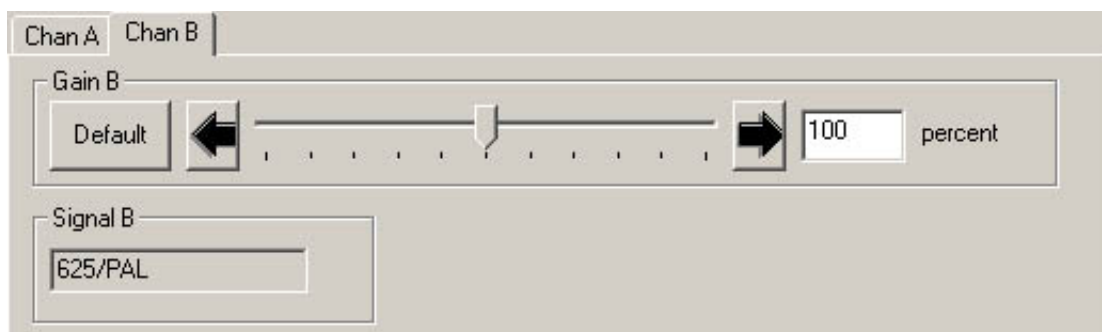

## Avenue Touch Screen Remote Configuration

Avenue Touch Screen remote control menus for this module are illustrated and explained below. Refer to the **5155 Parameter Table** for a summary of available parameters that can be set remotely through the menus illustrated. For more information on using Avenue Touch Screen, refer to the Avenue Touch Screen operating section of the Avenue System Overview.

Parameter fields that are grayed out can indicate one of the following conditions:

- An option is not installed.
- The function is not active.
- The module is locked.
- The User Level set with Avenue PC is not accessible from the current User Level.

### 5155 Avenue Touch Screen Menus

In the **Chan A** menu shown below, set the following parameters:

- **Gain A** - set the gain of the analog output video to the desired setting (90-110%). Select the **Default** button to return to the factory default.

The following indicator is available in this menu:

- **Signal A** - will indicate the input signal status of the module and will display **No Input**, **525/NTSC**, **625/PAL**, **AES Audio**, or **Tri-Level Sync**.

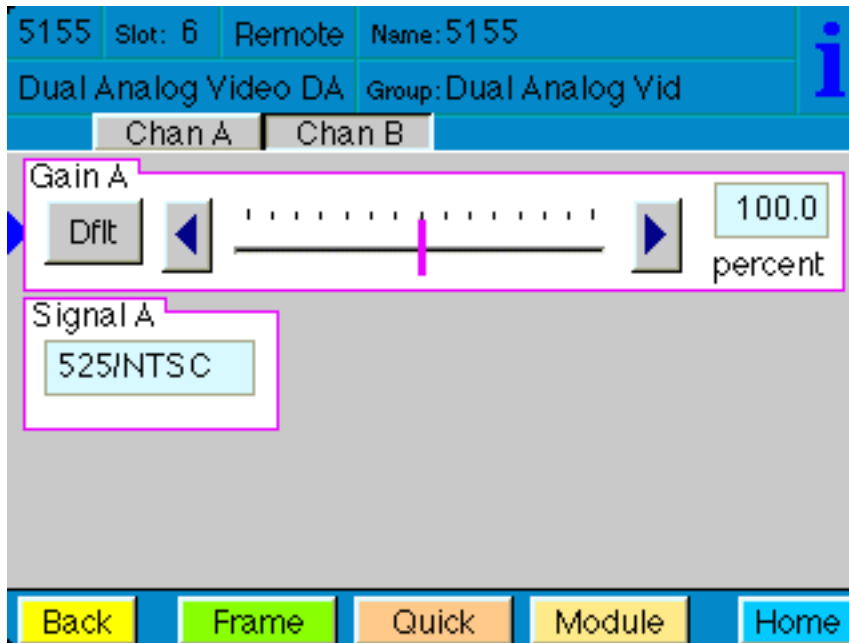



In the **Chan B** menu shown below, set the following parameters:

- **Gain B** - set the gain of the analog output video to the desired setting (90-110%). Select the **Default** button to return to the factory default.

The following indicator is available in this menu:

- **Signal B** - will indicate the input signal status of the module and will display **No Input**, **525/NTSC**, **625/PAL**, **AES Audio**, or **Tri-Level Sync**.

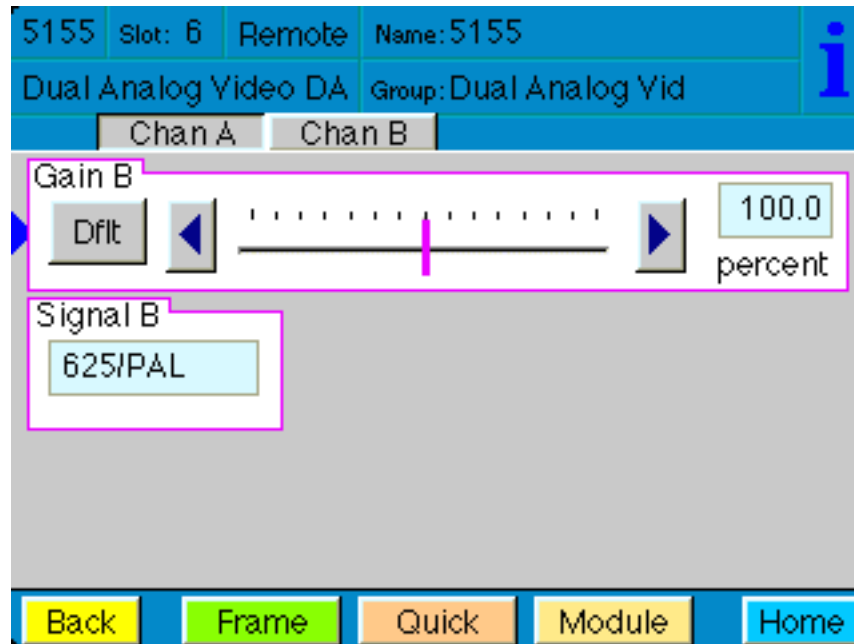

## TROUBLESHOOTING

To aid in troubleshooting, signal presence, power and CPU status can be easily monitored from the front panel of this module using the indicators explained in the previous section.

If using the **Remote** mode, the following status items can be monitored using the Avenue Touch Screen Control Panel or PC Application:

- Signal presence and validity
- Power status
- Slot ID, Software Version and Board Revision

Refer to the overall troubleshooting tips given below for the **5155** module:

### **No status lights are lit on front panel:**

- Check that frame power is present (green LED{s} on frame power supplies).
- Check that module is firmly seated in frame. Try removing it and plugging it in again.

### **Can't control module:**

- Check status of CPU **Run** green LED. Should be blinking slowly and in unison with other modules if System Control module is present. If not, try removing it and plugging it in again.
- System Control module may not be working properly if installed.

### **No analog signal out of module:**

- Check cabling to inputs of module and presence of valid signal.

### **No In OK indication:**

- Check for presence and validity of sync on input signals.

### **Module controls are grayed out:**

- Module is locked or access to module controls is restricted by User Level.
- Local/Remote switch on module is in the **Local** position.

You may also refer to the technical support section of the Ensemble web site for the latest information on your equipment at the URL below:

<http://www.ensembledesigns.com/support>

## SOFTWARE UPDATING

Software upgrades for each module can be downloaded remotely if the optional System Control module is installed. These can be downloaded onto your PC and then Avenue PC will distribute the update to the individual module. (Refer to the Avenue PC documentation for more information) Periodically updates will be posted on our web site. If you do not have the required System Control Module and Avenue PC, modules can be sent back to the factory for software upgrades.

## **WARRANTY AND FACTORY SERVICE**

### **Warranty**

This Module is covered by a five year limited warranty, as stated in the main Preface of this manual. If you require service (under warranty or not), please contact Ensemble Designs and ask for customer service before you return the unit. This will allow the service technician to provide any other suggestions for identifying the problem and recommend possible solutions.

### **Factory Service**

If you return equipment for repair, please get a Return Material Authorization Number (RMA) from the factory first.

Ship the product and a written description of the problem to:

Ensemble Designs, Inc.

Attention: Customer Service RMA #####

870 Gold Flat Rd.

Nevada City, CA. 95959 USA

(530) 478-1830

Fax: (530) 478-1832

service@endes.com

<http://www.ensembledesigns.com>

Be sure to put your RMA number on the outside of the box.

## SPECIFICATIONS

### 5155 Dual Analog Video DA

#### **Input Signal Description:**

Number: Two, terminating on module  
Signal Type: NTSC/525, PAL/625 composite video, Tri-level sync, or AES audio  
Impedance: 75 ohm  
Return Loss: 15k–5 MHz >40 dB

#### **Output Signal Description**

Number: Eight (four per input)  
Signal Type: NTSC/525, PAL/625 composite video, Tri-level sync, or AES audio  
Impedance: 75 ohm  
Return Loss: 15k–5 MHz >40 dB  
DC Follow input: +/- 50 mV  
Delay: 10 nS  
14 degrees NTSC, 17 degrees PAL  
Frequency Response: 300 kHz to 5.5 Mhz  
(referenced to 1 MHz) < +/- 0.1 dB  
K Factor, 2T Pulse: < 0.25% Kp  
Differential Phase: 10–90% apl < 0.1 degree  
Differential Gain: 10–90% apl < 0.15%

#### **General Specifications**

Power Consumption: < 3.0 Watts  
Temperature Range: 0 to 40 degrees C ambient (all specs met)  
Relative Humidity: 0 to 95% noncondensing  
Altitude: 0 to 10,000 ft  
Fusing: 1.5 Amp PTC resettable fuse

Due to ongoing product development, all specifications subject to change.